

CONTACT US

PARA LIGHT ELECTRONICS CO., LTD



+886-2-2225-3733



+886-2-2225-4800



para@para.com.tw



11F, No. 8, Jiankang Rd., Zhonghe Dist.,
New Taipei City 23586, Taiwan



website



wechat



COMMERCIAL LIGHTING

Led Lighting

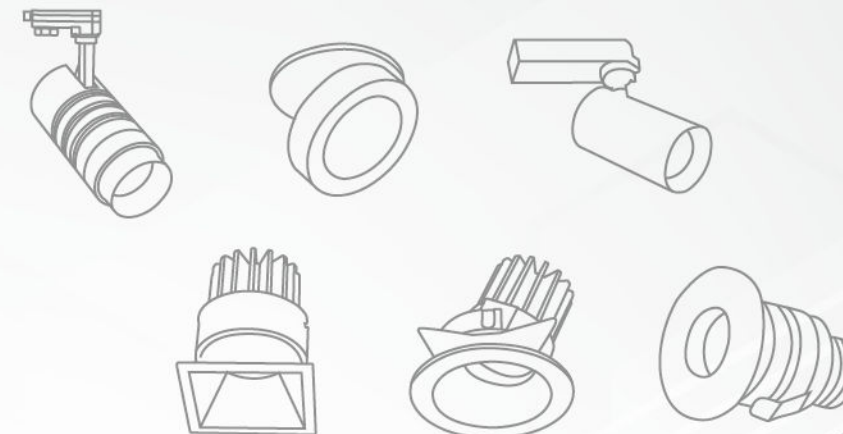

About Us

Chairman Mr. David Ma Capital USD 42 million
Established in 1987 No. of Employee 1073

Founded in 1987, PARA LIGHT is now a global innovator and leader in visible and invisible LED fields. With two manufacturing plants certified with ISO 14001, ISO 9001, IATF16969, and also complies with REACH and RoHS.



Contents

- 04 Recessed Light
- 10 Recessed Spotlight
- 14 Spotlight
- 20 Pendant Light
- 24 Slide Series
- 28 Downlight
- 32 Ceiling Light
- 36 Wall Sconce



LED Lightings

Recessed Light

Commercial Lighting

APPLICATIONS

- ◆ Ceiling, wall, track and ground to meet lighting needs.
- ◆ Provide more than just lighting, but also powerful solutions.
- ◆ Integrate lighting with aesthetics and functionality.



White



Black



Siler



PL-DL111A

IP 65

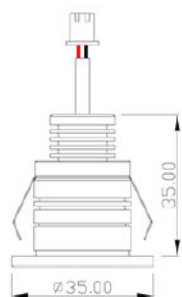

Product	LED	Power	Input Voltage	CCT	Optics
PL-DL111A	Bridgelux / CREE	2 W	DC 3 V 700mA	3000 / 4000 / 5000	15° / 25° / 30° / 40° / 60°

PL-RD1070K

Cut-out Ø 60 mm

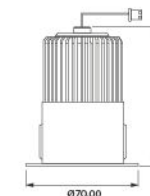

Product	LED	Diameter	Power	Height	Input Voltage	CCT	Optics
PL-RD1070K	Bridgelux C8	Ø 70 mm	9 W	87.8 mm	DC 37 V, 250 mA	2700 / 3000 / 4000 / 5000K	18° / 25° / 35°

PL-DM5070S

Cut-out Ø 63 mm

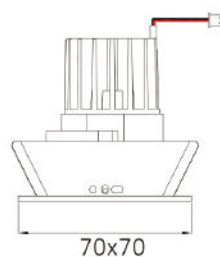

Product	LED	Power	Input Voltage	CCT	Optics
PL-DM5070S	Bridgelux / CREE	9 W	DC 36 V 25mA	3000 / 4000 / 5000	15° / 25° / 38° / 60°

PL-RD1092K

Cut-out Ø 75 mm

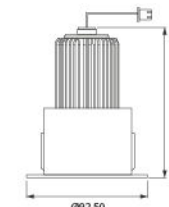

Product	LED	Diameter	Power	Height	Input Voltage	CCT	Optics
PL-RD1092K	Bridgelux V10B	Ø 92.5 mm	13 W	108.5 mm	DC 37 V, 350 mA	2700 / 3000 / 4000 / 5000K	18° / 25° / 35°

PL-DM5105S

Cut-out Ø 98 mm

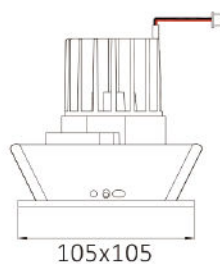

Product	LED	Power	Input Voltage	CCT	Optics
PL-DM5105S	Bridgelux / CREE	13 W	DC 36 V 35mA	3000 / 4000 / 5000	15° / 25° / 38° / 60°

PL-RD1125K

Cut-out Ø 100 mm

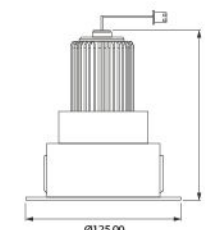

Product	LED	Diameter	Power	Height	Input Voltage	CCT	Optics
PL-RD1125K	Bridgelux V10B	Ø 125 mm	13 W	123.5 mm	DC 37 V, 350 mA	2700 / 3000 / 4000 / 5000K	18° / 25° / 35°

PL-DM4070D

Cut-out Ø 60 mm



Product	LED	Diameter	Power	Height	Input Voltage	CCT	Optics
PL-DM4070D	Bridgelux / CREE	Ø 70 mm	9 W	88 mm	DC 36 V, 250 mA	3000 / 4000 / 5000K	18° / 25° / 35°

PL-DM5093D

Cut-out Ø 80 mm



Product	LED	Diameter	Power	Height	Input Voltage	CCT	Optics
PL-DM5093D	Bridgelux / CREE	Ø 70 mm	13 W	88 mm	DC 36 V, 250 mA	3000 / 4000 / 5000K	15° / 25° / 38° / 60°

PL-DM5125D

Cut-out Ø 105 mm



Product	LED	Diameter	Power	Height	Input Voltage	CCT	Optics
PL-DM5125D	Bridgelux / CREE	Ø 125 mm	18 W	112 mm	DC 36 V, 250 mA	3000 / 4000 / 5000K	15° / 25° / 38° / 60°

Bullnose

Modern Design
Series products available
Smart Control Technology
Power 9 W / 13 W / 18 W

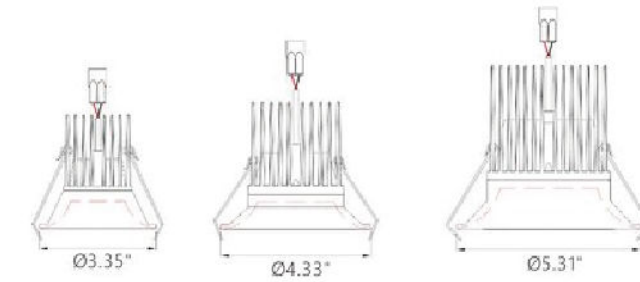

Lomo

One plaster kit with various rings
Easy shift between adjustable or non-adjustable version
Compatible with LED-Module or LED-GU10

Outer diameter : Ø120mm
Cut hole : Ø84mm

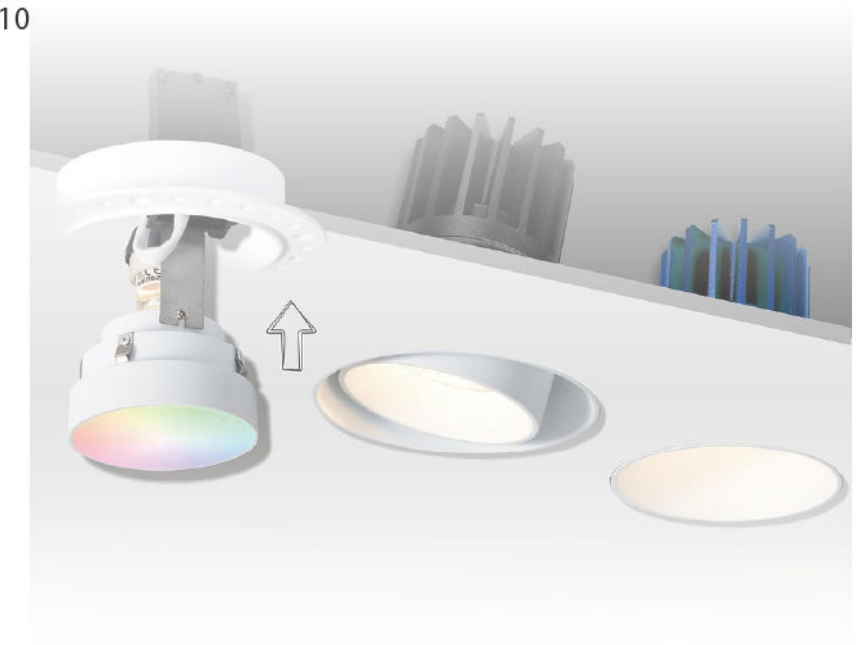



LED Lightings

Recessed Spotlight Commercial Lighting

APPLICATIONS

- ◆ Ceiling, wall, track and ground to meet lighting needs.
- ◆ Provide more than just lighting, but also powerful solutions.
- ◆ Integrate lighting with aesthetics and functionality.

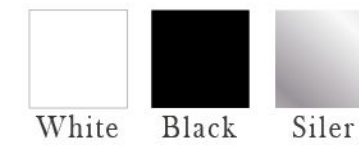

PL-RS1075B

IP 20 Cut-out Ø 76 mm

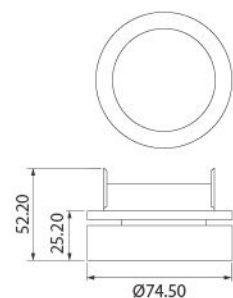

Product	LED	Diameter	Power	Height	Input Voltage	CCT	Optics
PL-RS1075B	Bridgelux V8E	Ø 74 mm	9 W	52 mm	DC 37 V, 250 mA	3000 / 4000 / 5000	11°

PL-RS1092B

IP 20 Cut-out Ø 76 mm

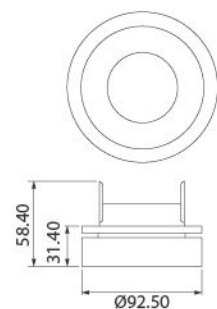

Product	LED	Diameter	Power	Height	Input Voltage	CCT	Optics
PL-RS1092B	Bridgelux V108E	Ø 92.5 mm	13 W	59 mm	DC 37 V, 350 mA	3000 / 4000 / 5000	11°

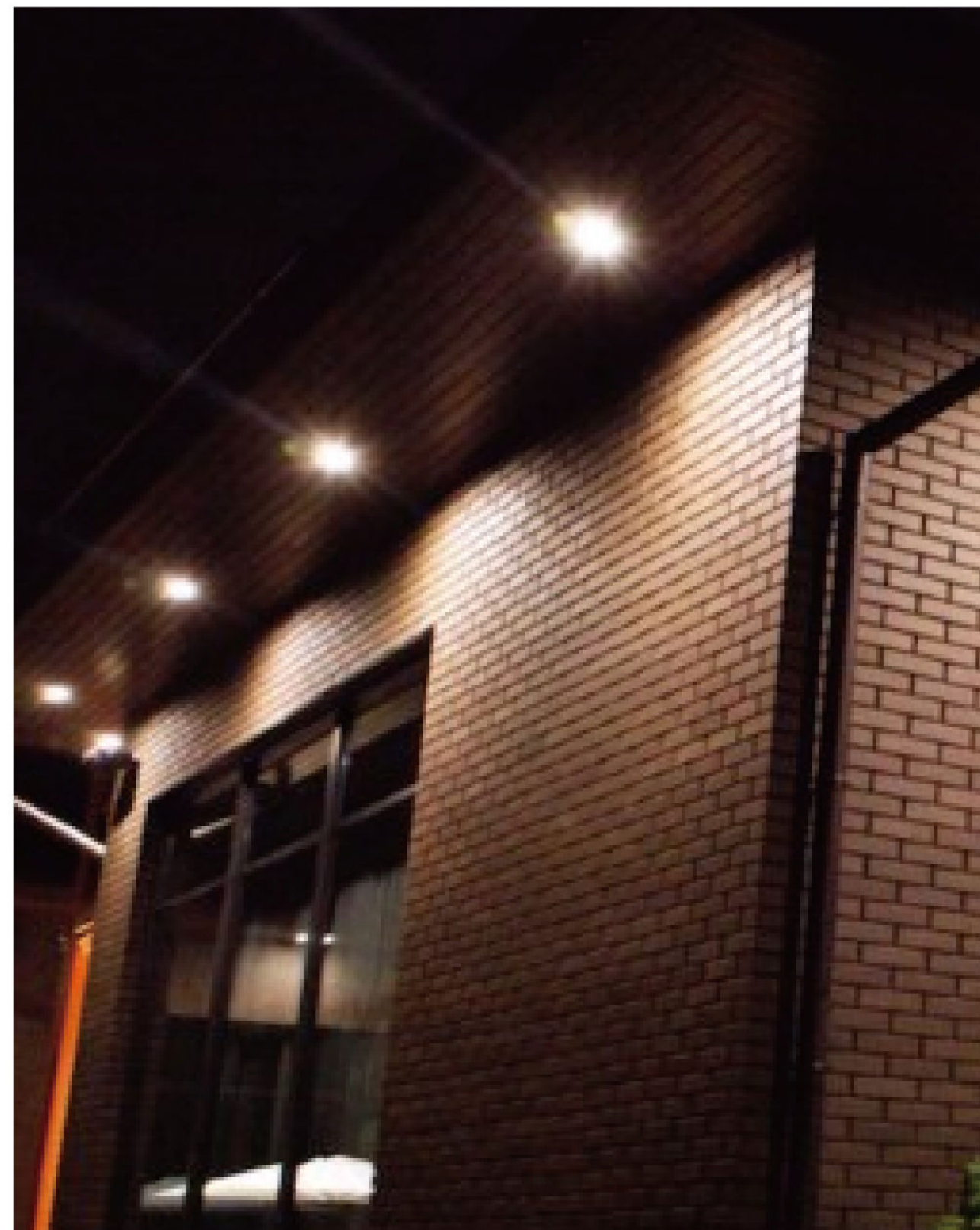



LED Lighting

Spotlight

Commercial Lighting

APPLICATIONS

- ◆ Ceiling, wall, track and ground to meet lighting needs.
- ◆ Provide more than just lighting, but also powerful solutions.
- ◆ Integrate lighting with aesthetics and functionality.

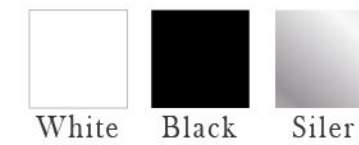

PL-RS018A

IP 20
 Micro Spotlight
 Simply styled
 Warm Dim Technology

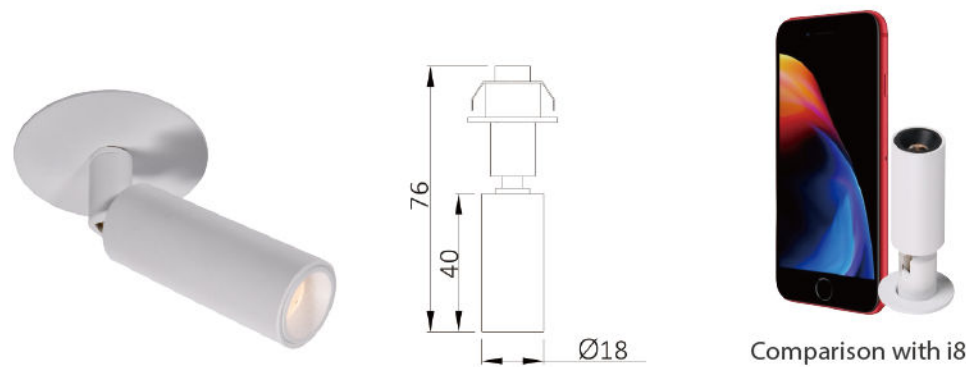

Product	LED	Power	Input Voltage	CCT	Optics
PL-RS018A	Bridgelux / CREE	8 W	AC 220 V	3000 / 4000 / 5000	15° / 25° / 38° / 60°

PL-T31045A

IP 20



Adaptor : compatible with most track systems
 Mounting types for options :



Interchangeable baffle

Product	LED	Diameter	Power	Height	Input Voltage	CCT	Optics
PL-T31045A	Bridgelux V8E (DC 250mA)	Ø 45 mm	9 W	151.5 mm	AC 110-230 V	2700 / 3000 / 4000 / 5000K	15° / 24° / 36°

PL-SP046MD

IP 20
 Driver-free
 Track or flush mount compatibilities
 Interchangeable frames and lens bring the wide variations

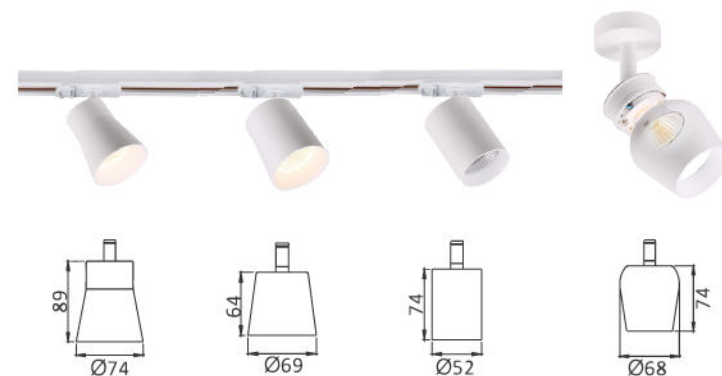

Product	LED	Power	Input Voltage	CCT	Optics
PL-SP046MD	Bridgelux / CREE	8 W	AC 220 V	3000 / 4000 / 5000	15° / 25° / 38° / 60°

PL-T31055A

IP 20



Product	LED	Diameter	Power	Height	Input Voltage	CCT	Optics
PL-T31055A	Bridgelux V8E (DC 300mA)	Ø 55 mm	11 W	151.5 mm	AC 110-230 V	2700 / 3000 / 4000 / 5000K	15° / 24° / 36°

PL-T31060A

IP 20



Product	LED	Diameter	Power	Height	Input Voltage	CCT	Optics
PL-T31060A	Bridgelux V8E (DC 350mA)	Ø 60 mm	13 W	120 mm	AC 110-230 V	2700 / 3000 / 4000 / 5000K	15° / 24° / 36°

Zoom

IP 44

- Stepless zoom 16-60
- Fully adjustable
- High lumen output
- UGR16
- Power 10 W / 20 W / 30 W



16°~60° Adjustable

PL-RS050C

- Sleek Design
- Smart Control Technology
- Track, Surface mountings
- Power 9 W max
- Optics Spot / Medium / Flood





LED Lighting

Pendant Light

Commercial Lighting

APPLICATIONS

- ◆ Ceiling, wall, track and ground to meet lighting needs.
- ◆ Provide more than just lighting, but also powerful solutions.
- ◆ Integrate lighting with aesthetics and functionality.



White



Black



Siler



PL-SF1088D

IP 20



Product	LED	Diameter	Power	Height	Input Voltage	CCT	Optics
PL-SF1088D	CREE CXA1512	Ø 88 mm	13 W	130 mm	220 ~ 230 V	2700 / 3000 / 4000 / 5000	15° / 25° / 38° / 60°

PL-SP1095A

IP 20

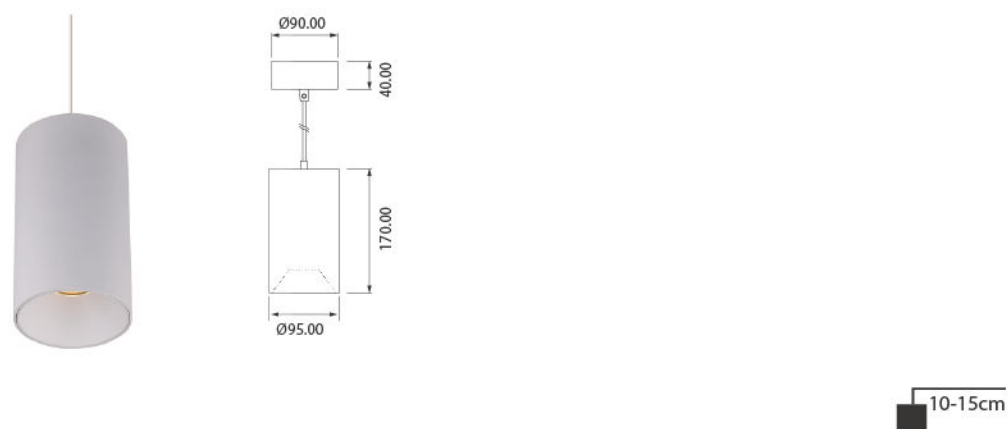

Product	LED	Diameter	Power	Height	Input Voltage	CCT	Optics
PL-SP1095A	CREE CXA1816	Ø 95 mm	18 W	230 mm	220 ~ 230 V	2700 / 3000 / 4000 / 5000	15° / 25° / 38° / 60°

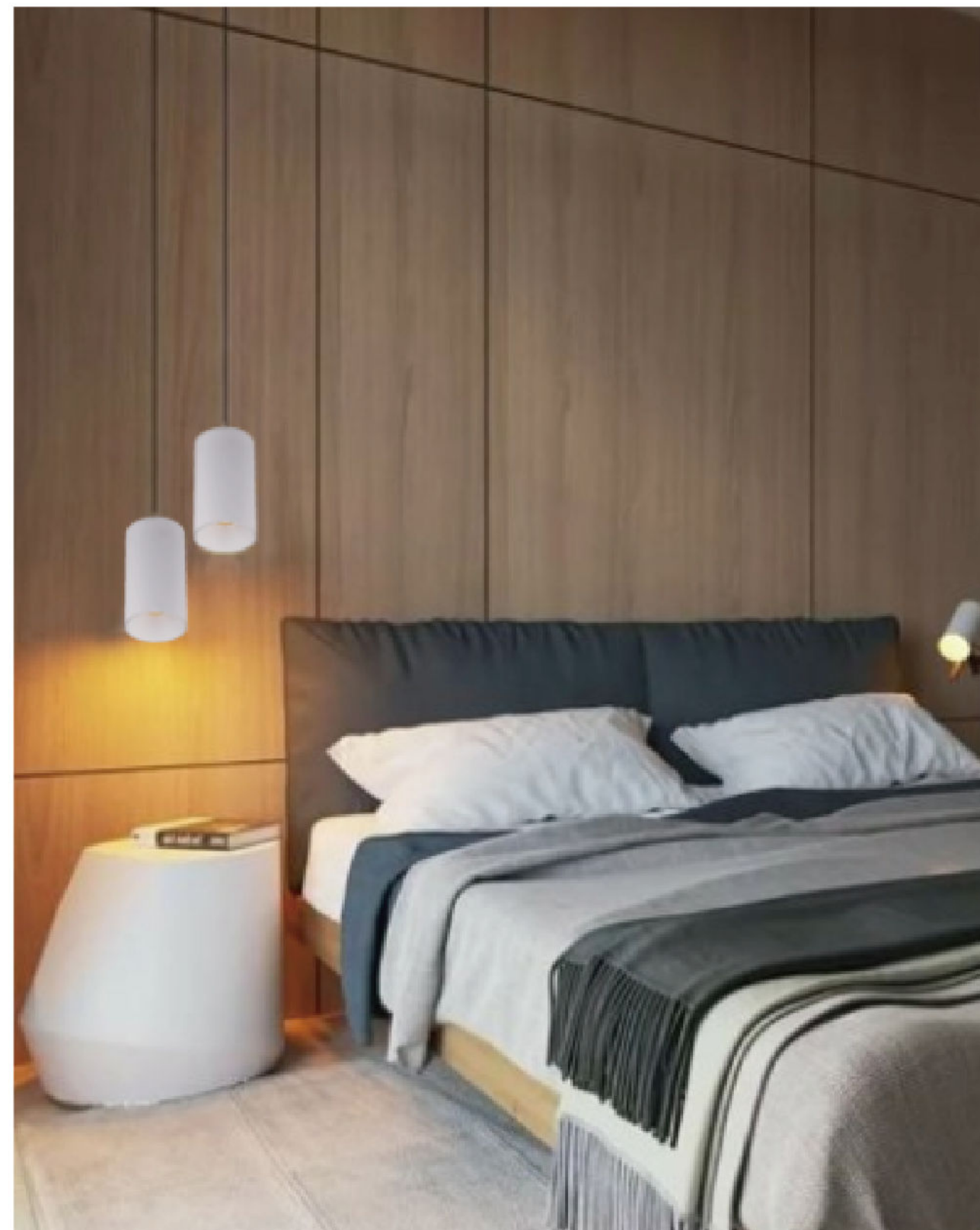



LED Lighting

Slide Series

Commercial Lighting

APPLICATIONS

- ◆ Ceiling, wall, track and ground to meet lighting needs.
- ◆ Provide more than just lighting, but also powerful solutions.
- ◆ Integrate lighting with aesthetics and functionality.

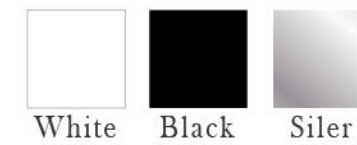

PL-RS1034A
 Cut-out Ø 55 mm

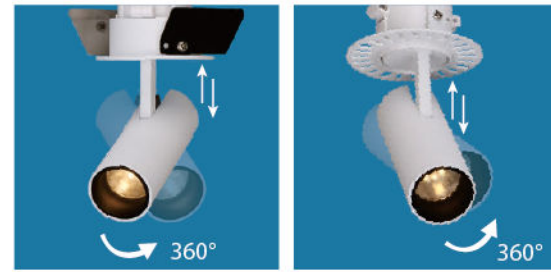
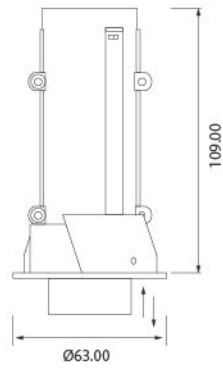

Product	LED	Diameter	Power	Height	Input Voltage	CCT	Optics
PL-RS1034A	LUMINES SST 20	Ø 63 mm	4.5 W	109 mm	DC 3V, 1500 mA	2700 / 3000 / 4000 / 5000	20° / 30° / 40°

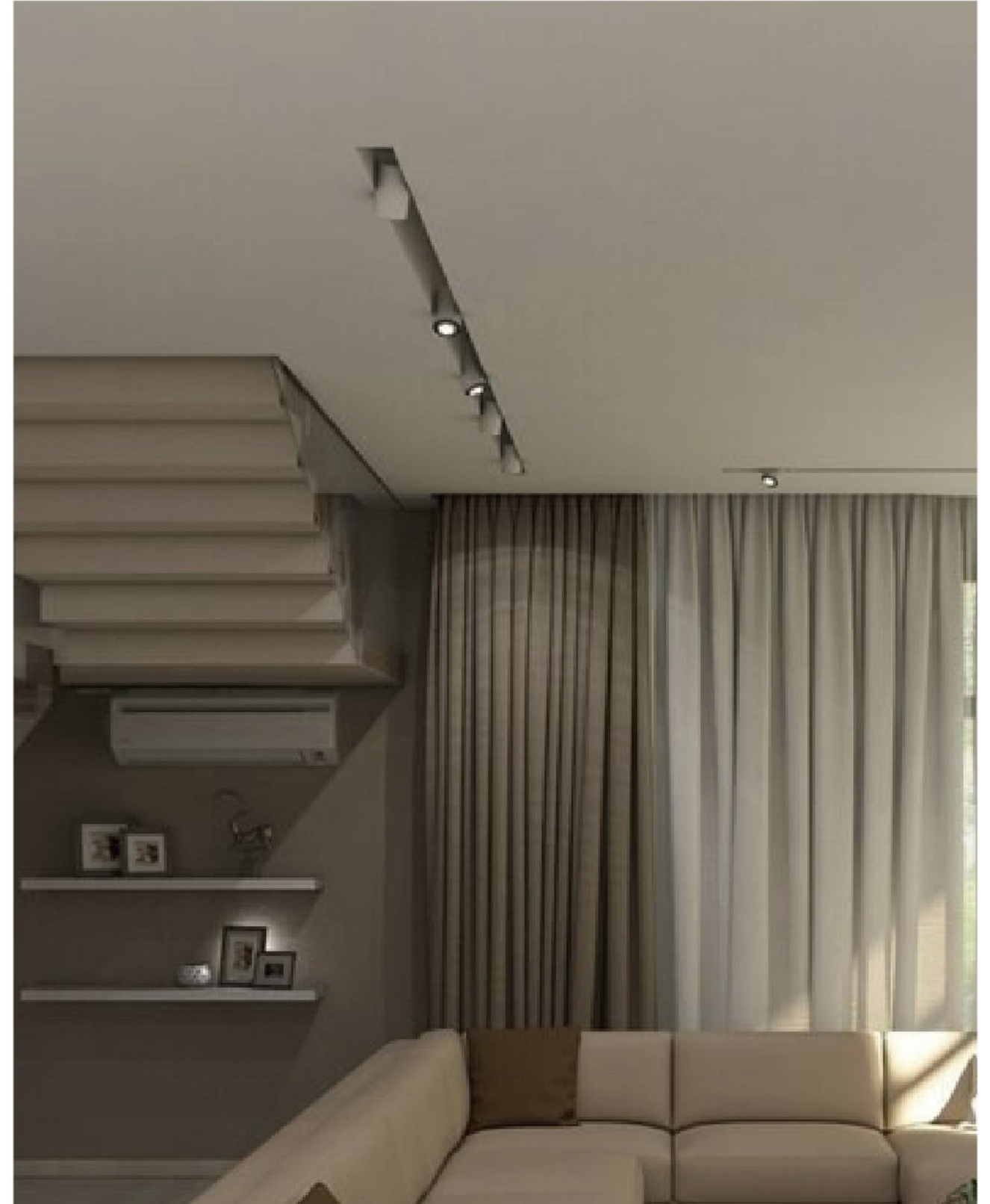



LED Lighting

Downlight

Commercial Lighting

APPLICATIONS

- ◆ Ceiling, wall, track and ground to meet lighting needs.
- ◆ Provide more than just lighting, but also powerful solutions.
- ◆ Integrate lighting with aesthetics and functionality.

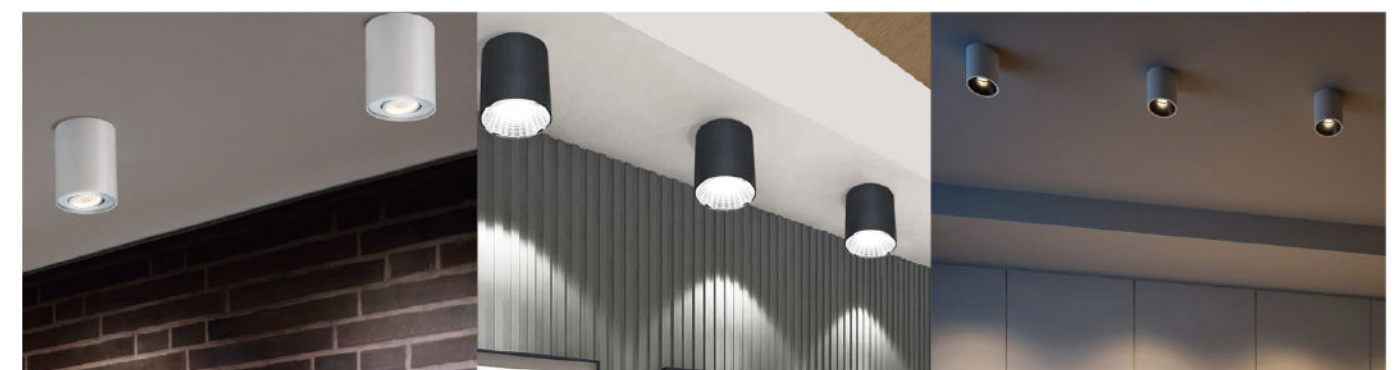
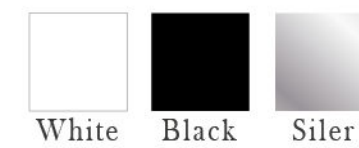

PL-SF1055A



Product	LED	Diameter	Power	Height	Input Voltage	CCT	Optics
PL-SF1055A	Bridgelux / CREE	Ø 55 mm	8 W	80 mm	AC 220 V	3000	15° / 25° / 38° / 60°

PL-SF1075A



Product	LED	Diameter	Power	Height	Input Voltage	CCT	Optics
PL-SF1075A	Bridgelux / CREE	Ø 75 mm	13 W	90 mm	AC 220 V	3000	15° / 25° / 38° / 60°

PL-SF1095A



Product	LED	Diameter	Power	Height	Input Voltage	CCT	Optics
PL-SF1095A	Bridgelux / CREE	Ø 95 mm	18 W	100 mm	AC 220 V	3000	15° / 25° / 38° / 60°





LED Lighting

Ceiling Light

Commercial Lighting

APPLICATIONS

- ◆ Ceiling, wall, track and ground to meet lighting needs.
- ◆ Provide more than just lighting, but also powerful solutions.
- ◆ Integrate lighting with aesthetics and functionality.

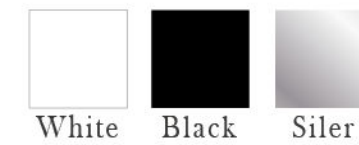

PL-DS1075B

✂ Cut-out Ø 65 mm



Product	LED	Diameter	Power	Height	Input Voltage	CCT	Optics
PL-DS1075B	Bridgelux / CREE	Ø 74.5 mm	9 W	52 mm	DC36V 250mA	3000/4000/5000	18° / 24° / 36°

PL-DS1092B

✂ Cut-out Ø 76 mm



Product	LED	Diameter	Power	Height	Input Voltage	CCT	Optics
PL-DS1092B	Bridgelux / CREE	Ø 92.5 mm	13 W	58 mm	DC36V 250mA	3000/4000/5000	18° / 24° / 36°





LED Lightings

Wall Sconce

Commercial Lighting

APPLICATIONS

- ◆ Ceiling, wall, track and ground to meet lighting needs.
- ◆ Provide more than just lighting, but also powerful solutions.
- ◆ Integrate lighting with aesthetics and functionality.

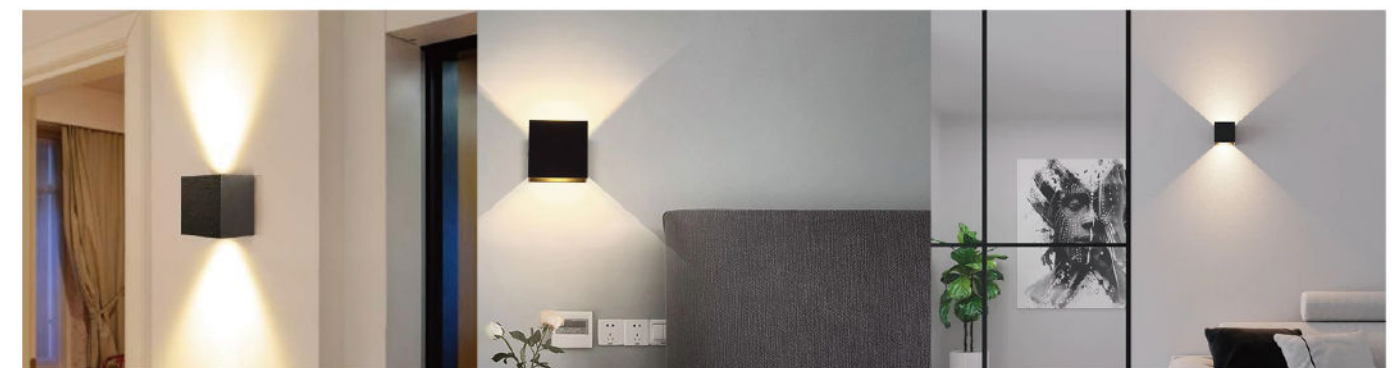
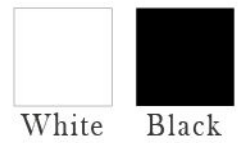

Vexar

Variety of beamspread
Square / Round shape
Interior / Exterior
Power 7 W / 12 W

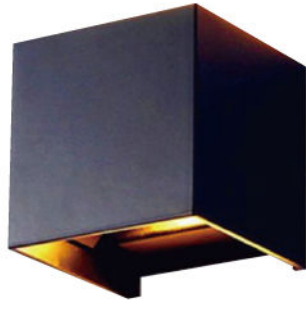

Headquarter

光鼎電子股份有限公司 Para Light Electronics Co., Ltd.

新北市中和區建康路8號11樓
11F, No. 8, Jiankang Rd., Zhonghe Dist.
New Taipei City, 23586 Taiwan
T +886-2-2225-3733 F +886-2-2225-4800
para@para.com.tw www.para.com.tw

Branch Offices

美國光鼎分公司 Para Light Corp. USA

515 Spanish Lane, Suite B, Walnut, CA 91789
F+909-468-4876 T+909-468-4866
sales@paralightusa.com www.paralightusa.com

印度光鼎分公司 Para Light India Pvt. Ltd.

No.979, 9th Floor, Aggarwal Cyber Plaza-2,
Netaji Subhash Place, Pitampura, New Delhi- 110034, India
T+011-41086226
abhinav.jha@para-india.com www.para.com.tw

連雲港光鼎電子有限公司 Para Light Lianyungang Electronics Co., Ltd.

中國江蘇省連雲港市灌南縣經濟開發區威海路8號
No.8, Wei Hai Rd., Guannan Economics Deveopment Zone,
Lianyungang City, Jiangsu Province, 223500, China
T+86-518-8369-2888 F+86-518-8369-2899
para@para.com.tw www.para.com.tw/zh-hans/

南京華鼎電子有限公司 Para Light Nanjing Electronics Co., Ltd.

中國江蘇省南京市江寧區湯山街湯泉西路1號
No.1, Tanguan W. Rd., Tangshan Ave., Jianning Dist. Nanjing City,
Jiansu Province, 211131 China
T+86-25-8410-7685 F+86-25-8410-7684
para@para.com.tw www.para.com.tw/zh-hans/

緬甸光鼎電子有限公司(仰光) Para Light Yangon Electronics Co., Ltd. (Myanmar)

No. 212, Pyin Si Minthar Gyi Street, Shwe Lin Ban Industry,
Hlaing Thar Yar Township, Yangon, Myanmar
T+95-9776964540
susie@parahk.com www.para.com.tw

Factories

Greater China Sales Teams

蘇州光鼎電子有限公司 East China Para Light (SUZHOU) Electronics Co., Ltd.

蘇州新區獅山路199號新地中心2104室
Room 2104, Xindi Center Building, No.199, Shishan Road Suzhou City,
Jiangsu Province, 215011 China
T+86-137-6164-0200 F+86-512-6809-7669
slssz@paralight.com.cn

光鼎深圳實業有限公司 South China Para Light (SHENZHEN) Electronics Co., Ltd.

中國深圳市龍華區龍華街道龍觀東路57號時代大廈1310-1312室
Room 1310-1312, Times Building, No. 57 Long Guan Dong Road,
Longhua Street, Longhua District, Shenzhen, 518110 China
T+86-189-2747-1103
eddy@paralight.com.cn

青島光鼎電子有限公司 North China Para Light (QINGDAO) Electronics Co., Ltd.

山東省青島市市北區山東路109號3號樓2901室
Room 2901, Building 3, No. 109 Shandong Road, Shibe District,
Qingdao, Shandong Province, 266000 China
T+0532-85692571 / 18626429477



Para Light Headquarters

Para Light Lianyungang



Para Light Nanjing

Para Light USA

Para Light India

Para Light Yangon