

DATA SHEET

PART NO. : SA403UW257

REV : A / 0

CUSTOMER'S APPROVAL : \_\_\_\_\_

DCC : \_\_\_\_\_

DRAWING NO. : DS-13-26-0043G

DATE : 2026-05-25

Page : 1

LD-R/R005

# 0.40 Single Digits SMD Type LED Display

SA403UW257

REV:A / 0

## PACKAGE DIMENSIONS

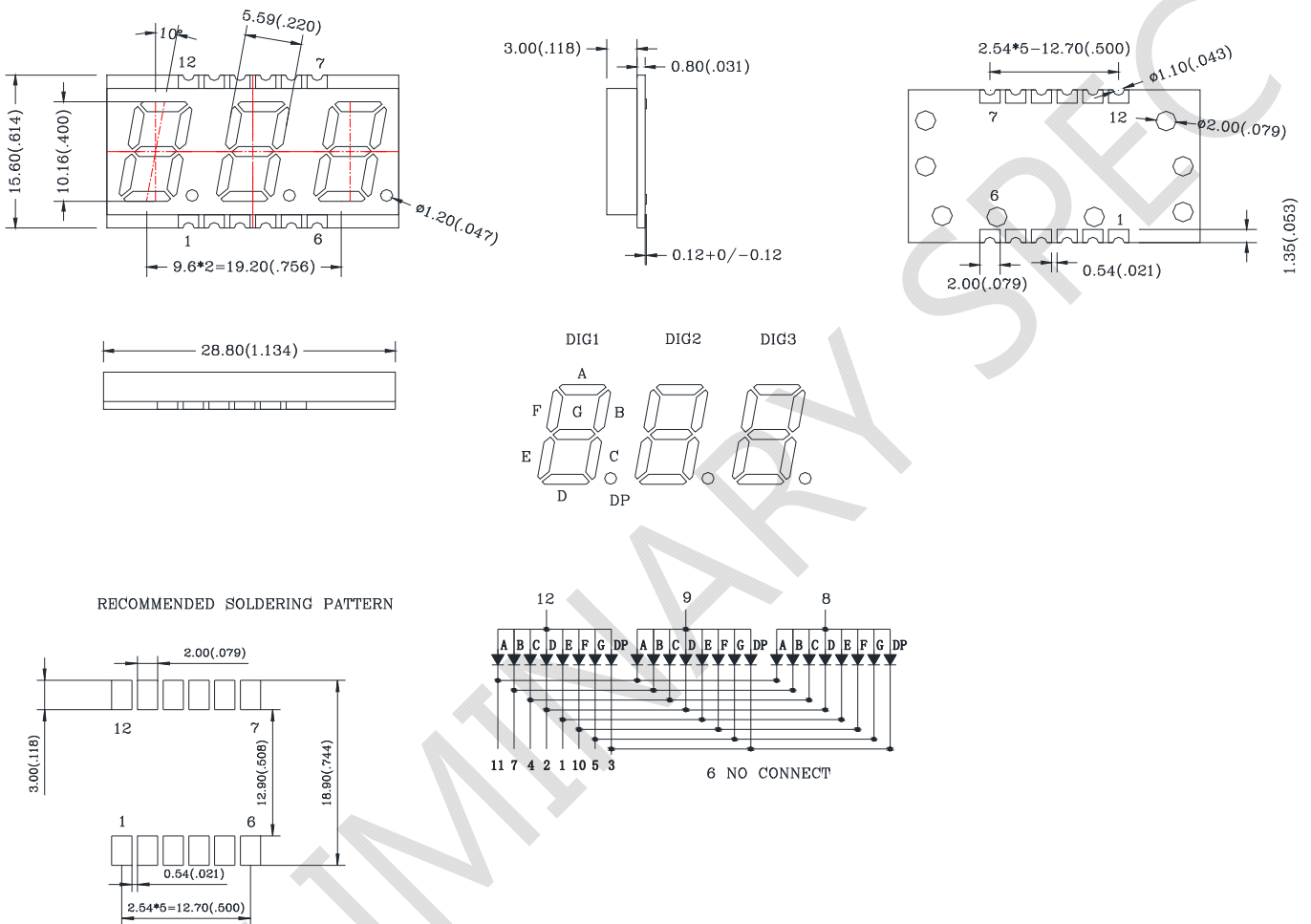

- NOTES :
1. All dimensions are in millimeters.
  2. Tolerance is  $\pm 0.25(0.010)$  unless otherwise specified.
  3. The specifications, electrical characteristics and technical data described in this datasheet are subject to change without prior notice

# 0.40 Single Digits SMD Type LED Display

**SA403UW257**

REV:A / 0

## FEATURES

- \* 10.16mm (0.40 inch ) DIGIT HEIGHT
- \* COMMON ANODE
- \* SMD TYPE
- \* MOISTURE SENSITIVITY LEVEL: 2a
- \* LOW POWER CONSUMPTION
- \* Pb FREE PRODUCTS
- \* ROHS COMPLIANCE
- \* GRAY FACE,WHITE SEGMENTS

Raw Material : SMD:InGaN/Ga/N

ABSOLUTE MAXIMUM RATING : ( Ta = 25°C )

SYMBOL	PARAMETER	WHITE	UNIT
PD	Power Dissipation Per Segment	32	mW
VR	Reverse Voltage Per Segment	5	V
IAF	Continuous Forward Current Per Segment	10	mA
IPF	Peak Forward Current Per Segment (1/10 Duty Cycle,0.1ms Pulse Width)	80	mA
ESD	Electrostatic Discharge Threshold (HBM)	1000	V
Topr	Operating Temperature Range	- 40°C to 85°C	
Tstg	Storage Temperature Range	- 40°C to 85°C	

ELECTRO-OPTICAL CHARACTERISTICS : ( Ta = 25°C )

SYMBOL	PARAMETER	TEST CONDITION	MIN.	TYP.	MAX.	UNIT
VF	Forward Voltage , Per Segment	IF = 5mA	-	2.8	3.2	V
IR	Reverse Current , Per Segment	VR = 5V		-	10	μA
X	Chromaticity Coordinates	IF = 5mA		0.27		
Y		IF = 5mA		0.28		
IV	Luminous Intensity Per Segment	IF = 5mA	17.2	43.0		mcd

# 0.40 Single Digits SMD Type LED Display

SA403UW257

REV:A / 0

FORWARD CURRENT Vs.  
FORWARD VOLTAGE

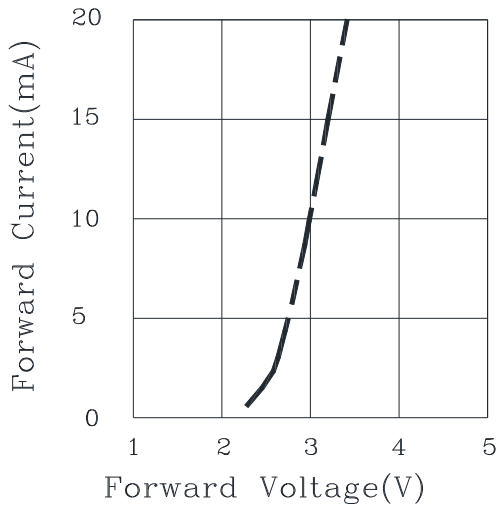

RELATIVE INTENSITY Vs.  
FORWARD CURRENT

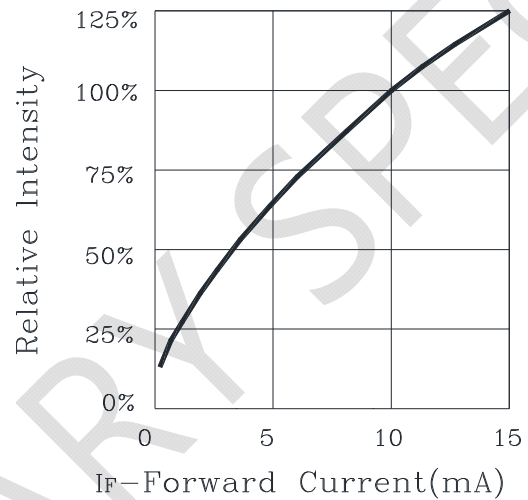

FORWARD CURRENT  
DERATING CURVE

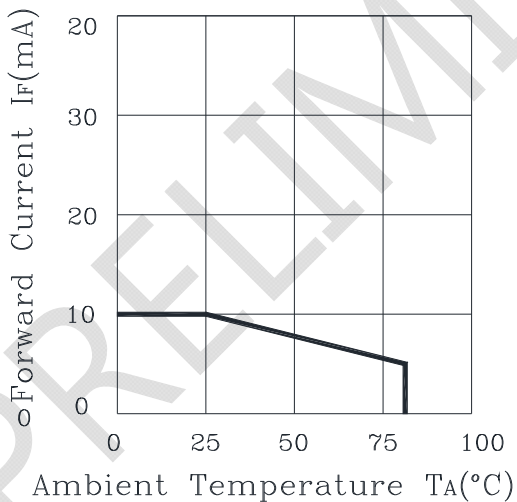

LUMINOUS INTENSITY Vs.  
AMBIENT TEMPERATURE

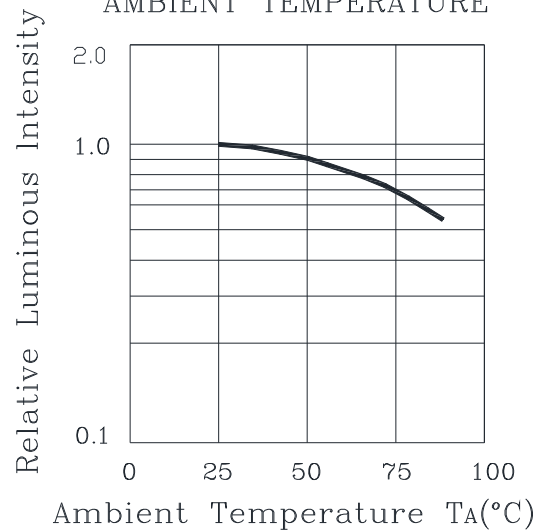

# 0.40 Single Digits SMD Type LED Display

SA403UW257

REV:A / 0

## CIRCUIT DESIGN NOTES

1. Protective current-limiting resistors may be necessary to operate the LEDs within the specified range.
2. LEDs mounted in parallel should each be placed in series with its own current-limiting resistor.
3. The driving circuit should be designed to protect the LED against reverse voltages and transient voltage spikes when the circuit is powered up or shut down.
4. The safe operating current should be chosen after considering the maximum ambient temperature of the operating environment.
5. Prolonged reverse bias should be avoided, as it could cause metal migration, leading to an increase in leakage current or causing a short circuit.

Recommended Set-up

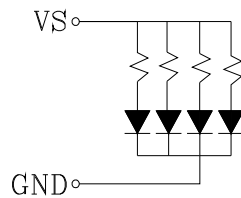

Invalid Set-up

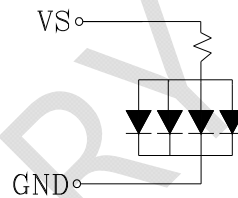

## SMT REFLOW SOLDERING INSTRUCTIONS

SMT Soldering Profile

Pb free reflow soldering Profile

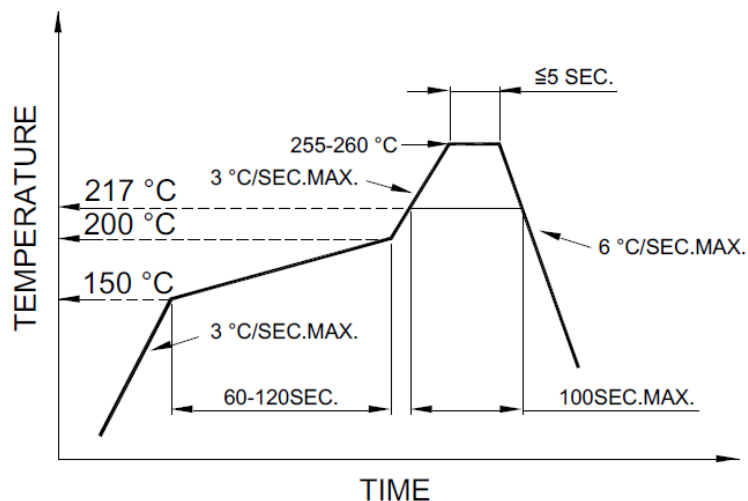

## NOTES

1. Avoid causing stress to the LEDs while it is exposed to high temperature.
2. The maximum number of reflow soldering passes is no more than 1 times.
3. Reflow soldering is recommended. Other soldering methods are not recommended as they might cause damage to the product.