



PARA LIGHT ELECTRONICS CO., LTD.

11F., No. 8, Jiankang Rd., Zhonghe Dist., New Taipei City 235, Taiwan,
Tel: 886-2-2225-3733 Fax: 886-2-2225-4800
E-mail: para@para.com.tw <http://www.para.com.tw>

DATA SHEET

PART NO.: LT1808KGCT-S60

REV: A/2

CUSTOMER'S APPROVAL : _____

DCC : _____

DRAWING NO.:DS-31P-21-0045

DATE: 2021-11-09

Page

1

● **Features**

- Top view, wide view angle.
- Suitable for all SMT assembly and solder process.
- High Luminous Intensity and high efficiency.
- Moisture sensitivity level: Level 5a.
- Available on tape and reel.
- RoHS compliant.
- Pb-free.

● **Applications**

- Automotive.
- Decorative and Entertainment Lighting.
- Indicators, Consumer, Industrial, Electronics.

● **Package Dimensions**

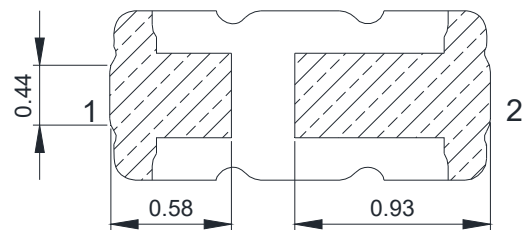
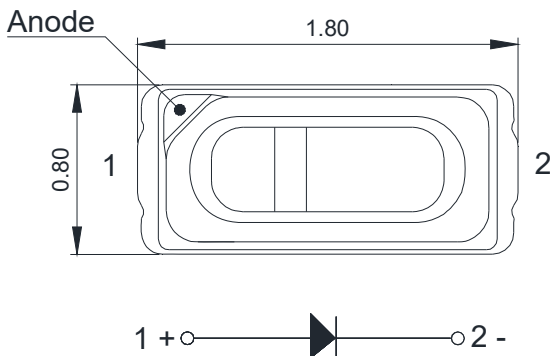

Recommended pad size

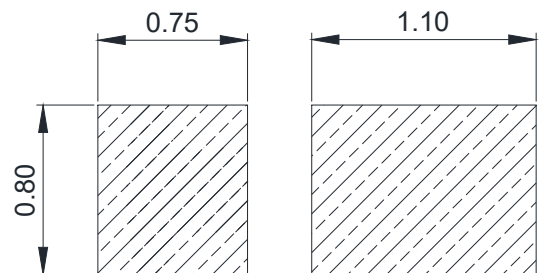

Notes:

1. All dimensions are in millimeters (inches).
2. Tolerance is $\pm 0.254\text{mm}$ (0.01") unless otherwise specified.
3. Lead spacing is measured where the leads emerge from the package.
4. Specifications are subject to change with notice.



SURFACE MOUNT DEVICE LED

LT1808KGCT-S60

REV: A/2

● Selection Guide

| Dice | Lens Type | Luminous Intensity (mcd)@20mA | | | Viewing Angle 2θ1/2 |
|-------------------------|----------------|-------------------------------|------|------|---------------------|
| | | Min. | Typ. | Max. | |
| Yellow Green AlGaInP | Water Clear | 42 | - | 90 | 120° |

● Electrical and optical characteristics(Ta=25°C)

| Items | Symbol | Condition | Min. | Typ. | Max. | Unit |
|---------------------|--------|-----------|------|------|------|------|
| Forward Voltage | VF | IF=20mA | 1.8 | - | 2.2 | V |
| Reverse Current | IR | VR=5V | - | - | 5 | uA |
| Dominant Wavelength | WD | IF=20mA | 570 | - | 576 | nm |

● Absolute Maximum Ratings At(Ta=25°C)

| Items | Symbol | Rating | Unit |
|------------------------------|--------|--|------|
| Power Dissipation | PD | 60 | mW |
| Forward Current | IF | 30 | mA |
| Peak Forward Current | IFP | 70 | mA |
| Reverse Voltage | VR | 5 | V |
| Electrostatic Discharge(HBM) | ESD | 1500 | V |
| Operating Temperature Range | Topr | -40°C ~ +95°C | |
| Storage Temperature Range | Tstg | -40°C ~ +95°C | |
| Lead Soldering Temperature | Tsol | Reflow soldering : 260°C For 10 Seconds Hand soldering: 300°C For 3 Seconds | |

●Bin Code List

| Luminous Intensity(IV), Unit:mcd@20mA | | |
|---------------------------------------|------|------|
| Bin Code | Min. | Max. |
| - | 42 | 56 |
| - | 56 | 72 |
| - | 72 | 90 |

Note: Tolerance for each Luminous Intensity Bin is $\pm 10\%$.

| Forward Voltage(VF), Unit:V @20mA | | |
|-----------------------------------|------|------|
| Bin Code | Min. | Max. |
| - | 1.8 | 2.0 |
| - | 2.0 | 2.2 |

Note: Tolerance for each Forward Voltage Bin is $\pm 10\%$.

| Dominant Wavelength (WD),Unit:nm @20mA | | |
|--|------|------|
| Bin Code | Min. | Max. |
| - | 570 | 573 |
| - | 573 | 576 |

Note: Tolerance for each Dominant Wavelength Bin is $\pm 1\text{nm}$.

● Typical electro-optical characteristics curves

Relative intensity VS wavelength

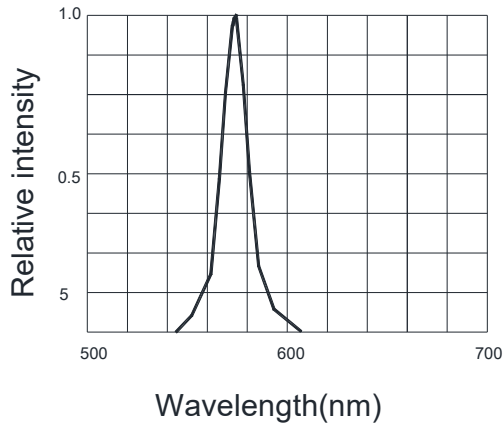

Current and ambient temperature

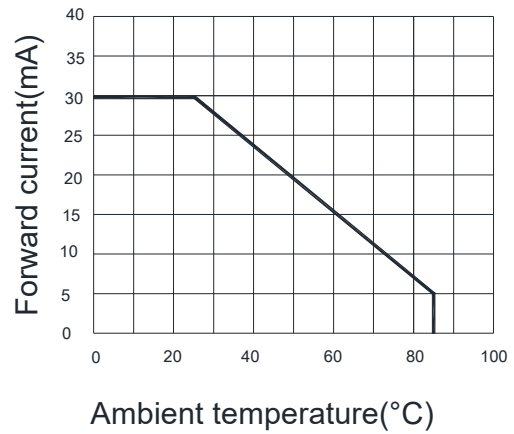

Voltage current relationship

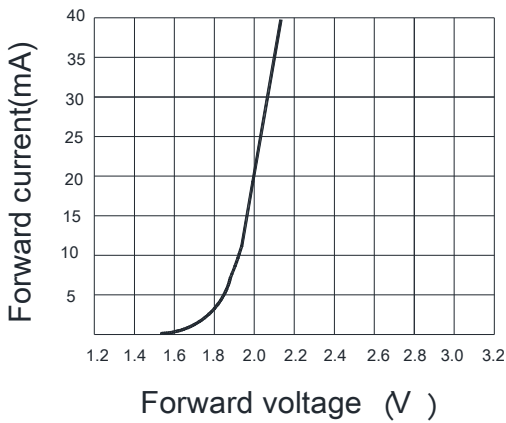

Relative light intensity vs ambient temperature

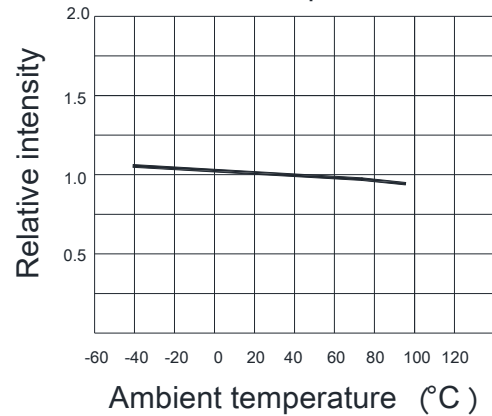

Relative light intensity vs current

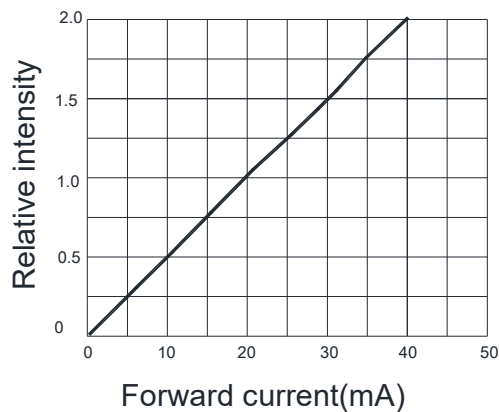

Radiation angle

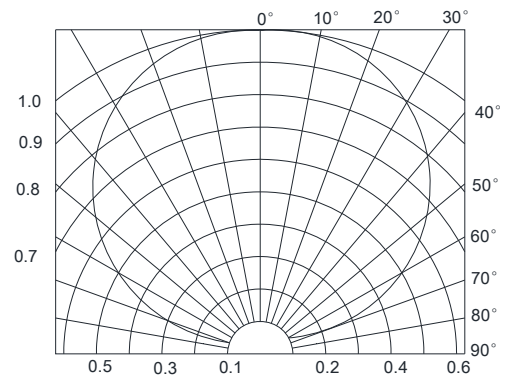

●Packaging

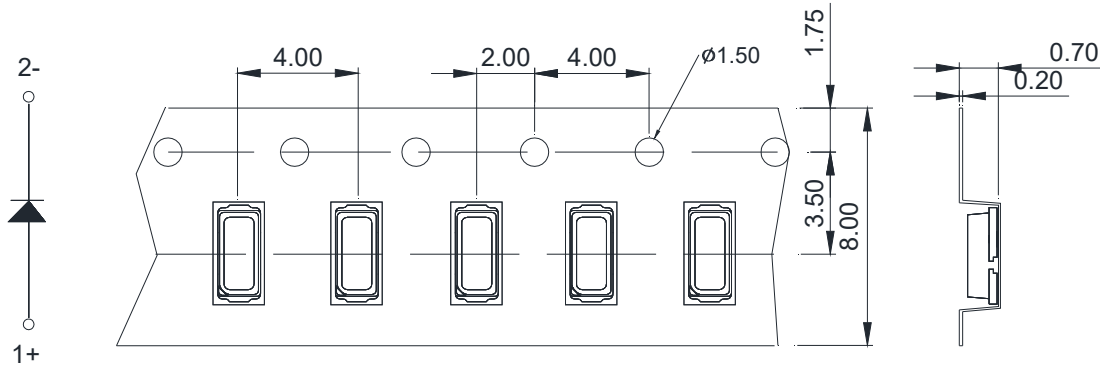

Note: Tolerance unless mentioned is ± 0.1 mm; Unit = mm

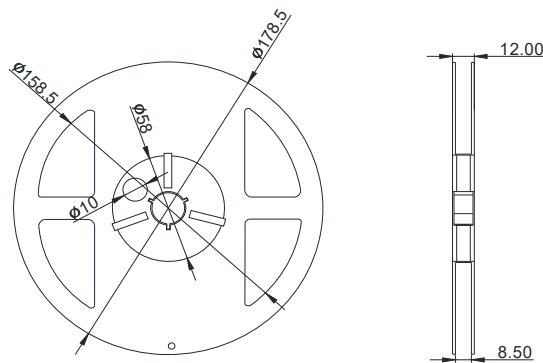

Carrier Tape Dimensions: Loaded Quantity 4000 pcs Per Reel

●Moisture Resistant Packaging

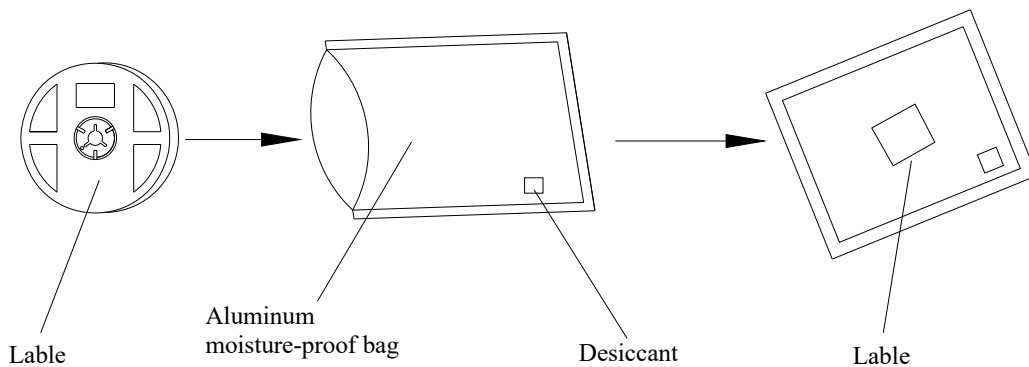

● **Precautions for Use**

• SMT Reflow Soldering Instructions

< Pb-free solder >

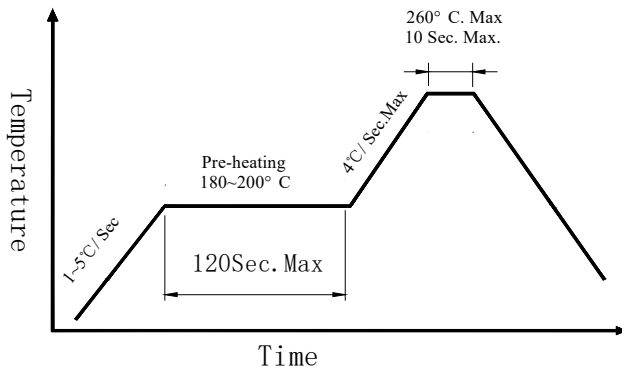

<Lead solder >

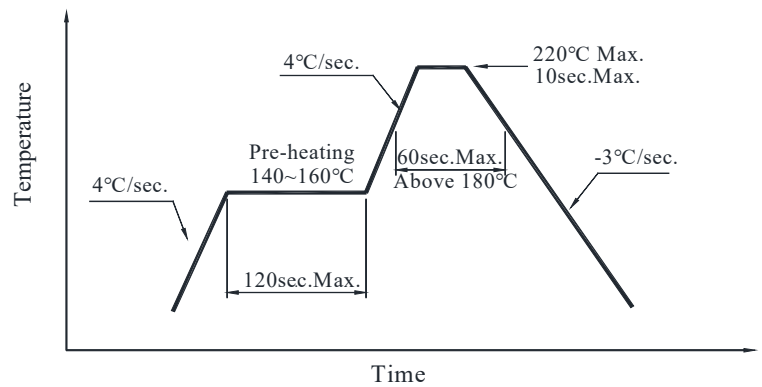

- 1.Reflow soldering should not be done more than two times
- 2.When soldering, do not put stress on the LEDs during heating

• **Soldering Iron**

1. When hand soldering, keep the temperature of iron below less 300°C less than 3 seconds.
2. The hand solder should be done only one time.

• **Repairing**

Repair should not be done after the LEDs have been soldered. When repairing is unavoidable, a double-head soldering iron should be used (as below figure).It should be confirmed in advance whether the characteristics of LEDs will or will not be damaged by repairing.

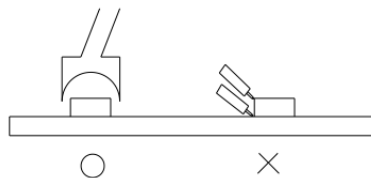

● **Cautions**

Application

- 1.A LED is a current-operated device. The slight shift of voltage will cause big change of current, which will damage LEDs. Customer should use resistors in series for the Over-Current-Proof.
- 2.In order to ensure intensity uniformity on multiple LEDs connected in parallel in an application, it is recommended to use individual resistor separately, as shown in Circuit A below.
The brightness of each LED shown in Circuit B might appear difference due to the differences in the I-V characteristics of those LEDs.

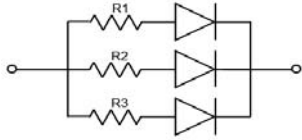

Circuit model A

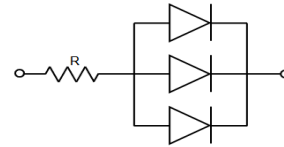

Circuit model B

High temperature may reduce LEDs' intensity and other performances, so keeping it away from heat source to get good performance is necessary.

Handling Precautions

Compare to epoxy encapsulant that is hard and brittle, silicone is softer and flexible. Although its characteristic significantly reduces thermal stress, it is more prone to damage by external mechanical force. As a result, special handling precautions must be observed during assembling using silicone encapsulated LED products. Failure to comply might leads to damage and premature failure of the LED.

1. Handle the component along the side surface by using forceps or appropriate tools, do not directly touch or handle the silicone lens surface, it may damage the internal circuitry.

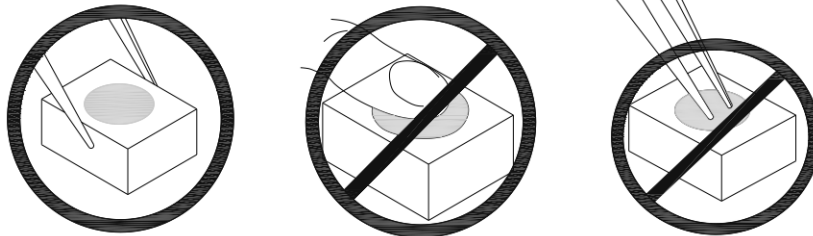

2. The outer diameter of the SMD pickup nozzle should not exceed the size of the LED to prevent air leaks. The inner diameter of the nozzle should be as large as possible. A pliable material is suggested for the nozzle tip to avoid scratching or damaging the LED surface during pickup. The dimensions of the component must be accurately programmed in the pick-and- place machine to insure precise pickup and avoid damage during production.

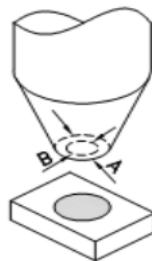

3. Do not stack together assembled PCBs containing LEDs. Impact may scratch the silicon lens or damage the internal circuitry.

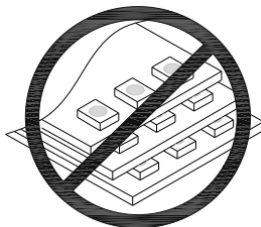

4. Not suitable to operate in acidic environment, PH<7.



Storage

1. Before opening the original package, it is recommended to store it in the following environment:
temperature: 5 °C ~ 30 °C / humidity: maximum relative humidity: 60%.
2. After opening original package, the storage ambient for the LEDs should be in 5~30°C temperature and 60% or less relative humidity.
3. In order to avoid moisture absorption, it is recommended that the LEDs that out of the original package should be stored in a sealed container with appropriate desiccant, or in desiccators with nitrogen ambient.
4. The LEDs should be used within 24hrs (1 day) after opening the package. Once been mounted, soldering should be quick.
5. If the moisture absorbent material (silica gel) has faded away or the LEDs stored out of original package for more than 168hrs (7 days), baking treatment should be performed using the conditions: 65°C at least 48 hours.
6. Less than three months of the products must be baked at 65±5°C/48 hours after opening package before they can be produced.
7. More than three months of the products must be returned to our company for high temperature baking at 150°C/4 hours.

ESD (Electrostatic Discharge)-Protection

A LED (especially the Blue White and Green product) is an ESD sensitive component, and static electricity or power surge will damage the LED. ESD-damaged LEDs will exhibit abnormal characteristics such as high reverse leakage current, low forward voltage, or “no light-up” at low currents, etc.



SURFACE MOUNT DEVICE LED

LT1808KGCT-S60

REV: A/2

Some advice as below should be noticed:

1. A conductive wrist strap or anti-electrostatic glove should be worn when handling these LEDs.
2. All devices, equipment, machinery, work tables and storage racks, etc. must be properly grounded.
3. Use anti-static package or boxes to carry and storage LEDs. And ordinary plastic package or boxes is forbidden to use.
4. Use ionizer to neutralize the static charge during handling or operating.
5. All surfaces and objects within 1 ft close to LEDs measure less than 100V.

Cleaning

Use alcohol-based cleaning solvents such as IPA (isopropyl alcohol) to clean LEDs if necessary.

Others

1. The LEDs described here are intended to be used for ordinary electronic equipment (such as office equipment, communication equipment and household applications). Consult light's Sales in advance for the applications in which exceptional reliability is required, particularly when the failure or malfunction of the LEDs may directly jeopardize life or health. (such as in aviation, transportation, traffic control equipment, medical and life support systems and safety devices).
2. The light output from the high luminous intensity LEDs may cause injury to human eyes when viewed directly.
3. The appearance and specifications of the product may be modified for improvement without prior notice.