



PARA LIGHT ELECTRONICS CO., LTD.

11F, No.8, Jiankang Rd,Zhonghe Dist,New Taipei City 235, Taiwan

Tel: 886-2-2225-3733

Fax: 886-2-2225-4800

E-mail: para@para.com.tw

<http://www.para.com.tw>

DATA SHEET

PART NO. : LS193TBCT-YY

REV : A / 1

CUSTOMER'S APPROVAL : _____

DCC : _____

DRAWING NO. : DS-51-20-053

DATE : 2021-11-20

Page : 1

PACKAGE DIMENSIONS

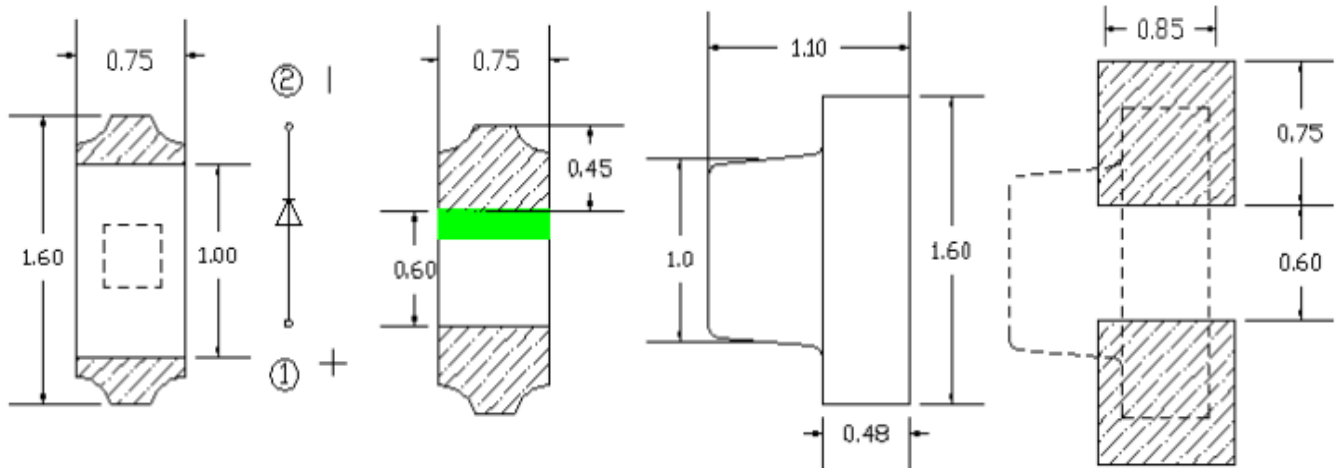

Notes:

1. All dimensions are in millimeters
2. Tolerance is ± 0.10 mm unless otherwise noted



1.6*0.75*1.1 mm SMD LED

LS193TBCT-YY

REV:A / 1

FEATURES

- Package (L/W/H) : 1.6*0.75*1.1 mm
- Color: Blue light
- Lens: Transparent planar colloid
- EIA STD Package
- Meet ROHS, Green Product
- Compatible With SMT Automatic Equipment
- Compatible With Infrared Reflow Solder Process

ABSOLUTE MAXIMUM RATING : (Ta = 25°C)

Parameter	Symbol	Rating	Unit
Power Dissipation	Pd	100	mW
Peak Forward	IFP	60	mA
DC Forward Current	IF	30	mA
Backward Voltage	VR	5	V
Operating Temperature Range	Topr	-40°C ~ + 85°C	
Storage Temperature Range	Tstg	-40°C ~ + 85°C	
Soldering Condition	Tsol	Reflow soldering : 260°C , 10s Hand soldering : 300°C , 3s	

ELECTRO-OPTICAL CHARACTERISTICS : (Ta = 25°C)

Parameter	Symbol	Min.	Typ.	Max.	Unit	Test Condition
Light Intensity	IV	34	58	100	mcd	IF = 5mA
Viewing Angle	2θ 1/2	---	120	---	deg	IF = 5mA
Dominant Wavelength	λ d	460	466	475	nm	IF = 5mA
Forward Voltage	VF	2.6	2.9	3.1	V	IF = 5mA
Backward Voltage	IR	---	---	5	μ A	VR = 5V
Spectral Line Half-Width	Δ λ		15		nm	IF = 5mA

Typical Electro-Optical Characteristics Curves

25°C Ambient Temperature Unless Otherwise Noted

Forward Current VS. Forward Voltage (Ta=25°C)

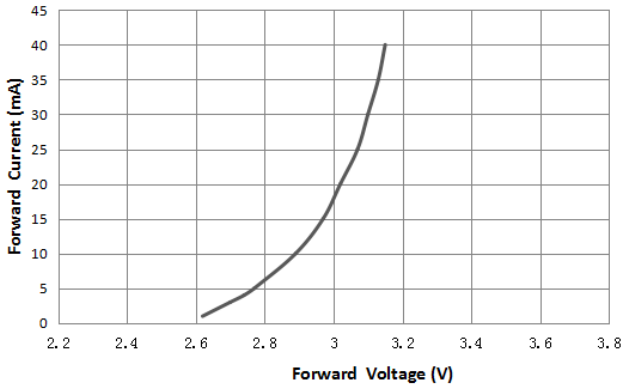

Spectrum Distribution (Ta=25°C)

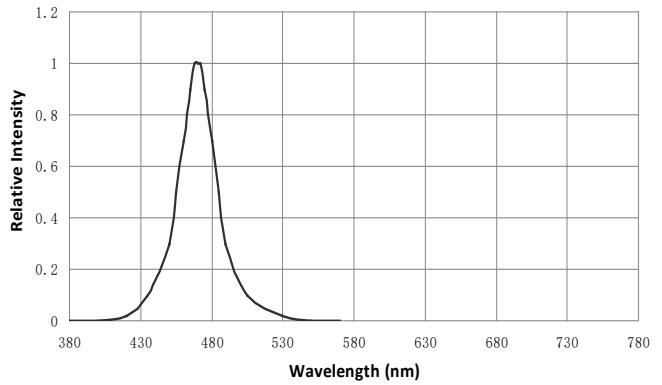

Relative Intensity VS. Ambient Temperature (Ta=25°C)

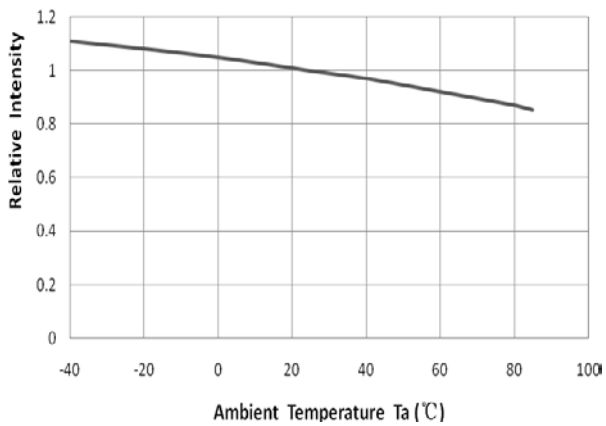

Relative Intensity VS. Forward Current (Ta=25°C)

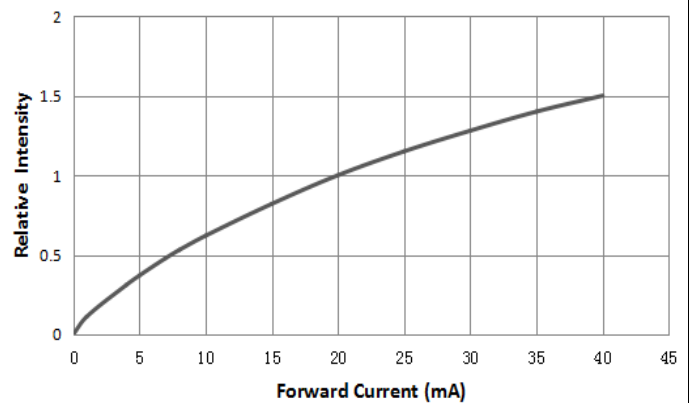

Maximum Forward Current VS. Ambient temperature

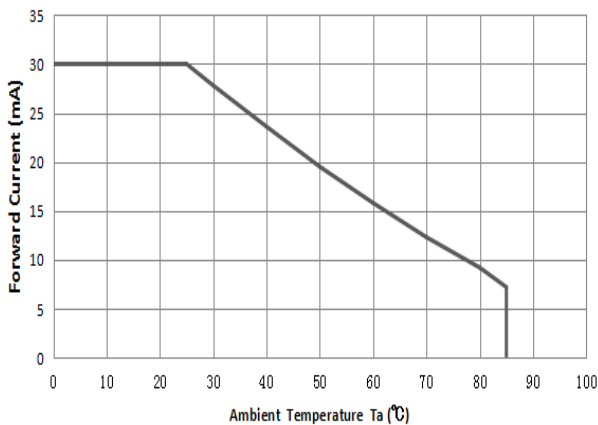
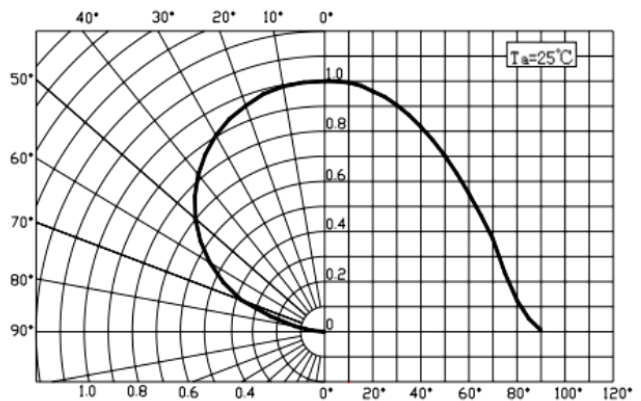

Diagram characteristics of radiation





1.6*0.75*1.1 mm SMD LED

LS193TBCT-YY

REV:A / 1

Bin Range of Luminous Intensity

Bin	Min	Max	Unit	Condition
P14	34	40	mcd	IF =5mA
P15	40	58		
P16	58	70		
P17	70	85		
P18	85	100		

Note: Tolerance of Luminous Intensity: $\pm 10\%$

Bin Range of Forward Voltage

Bin	Min	Max	Unit	Condition
VM	2.6	2.7	V	IF =5mA
VN	2.7	2.8		
VO	2.8	2.9		
VP	2.9	3.0		
VQ	3.0	3.1		

Note: Tolerance of Forward Voltage: $\pm 0.05V$.

Bin Range of Wavelength

Bin	Min	Max	Unit	Condition
B4	460	463	nm	IF = 5mA
B5	463	466		
B6	466	469		
B7	469	472		
B8	472	475		

Notes: Tolerance of Wavelength: $\pm 1nm$

Reel And Tape Dimensions

Packing quantity: 4000 PCS/rolls

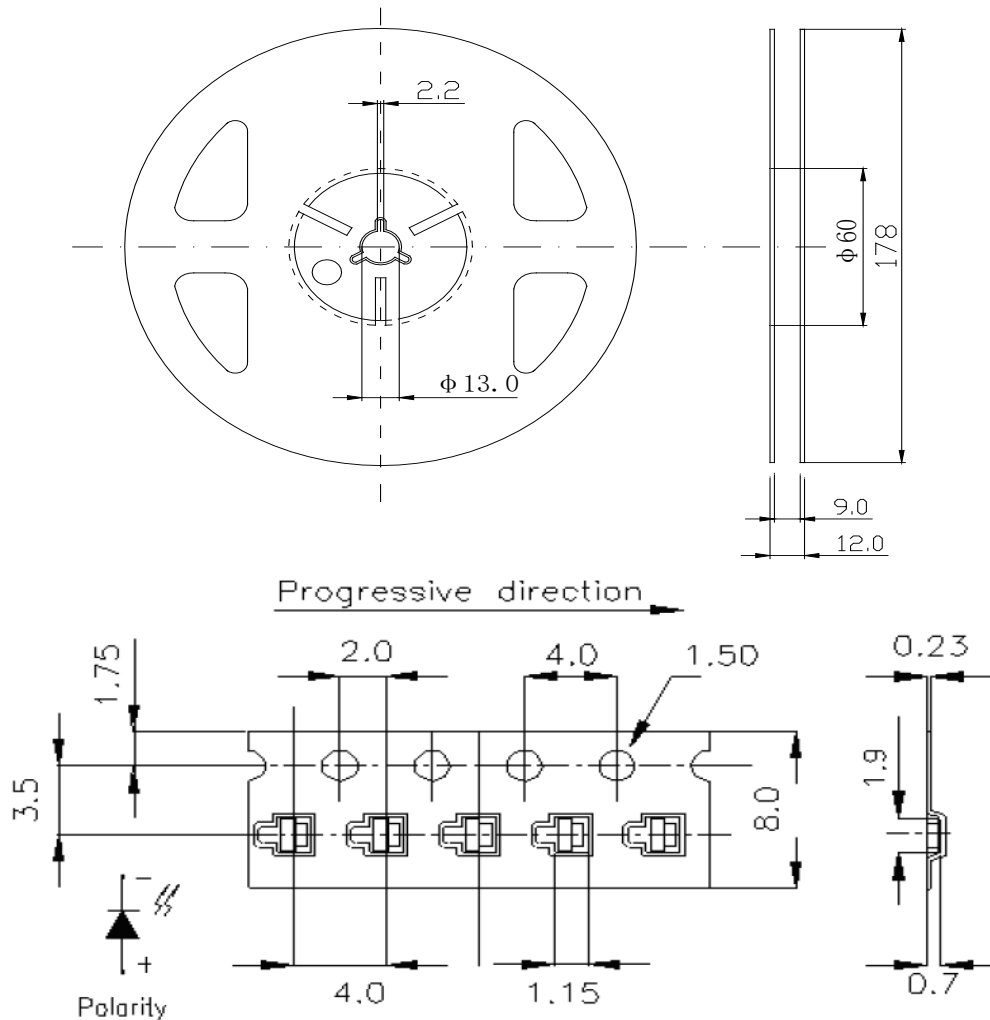

Notes:

1. All dimensions are in millimeters.
2. Tolerance is ± 0.1 mm unless otherwise noted

Label Explanation :

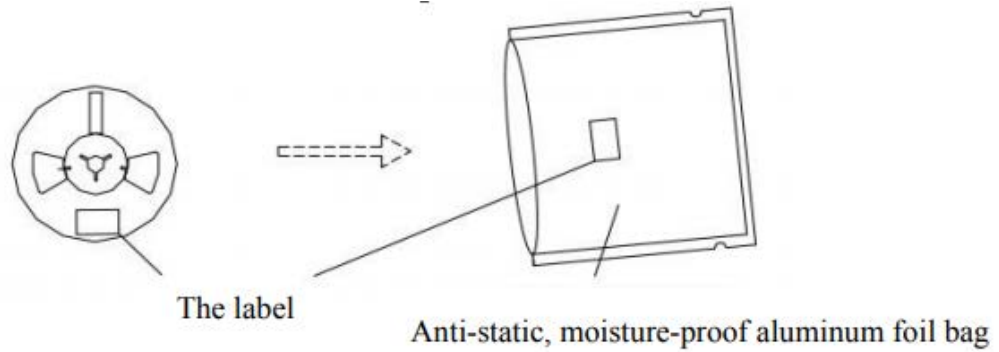

Soldering Profile Suggested

lead-free solder

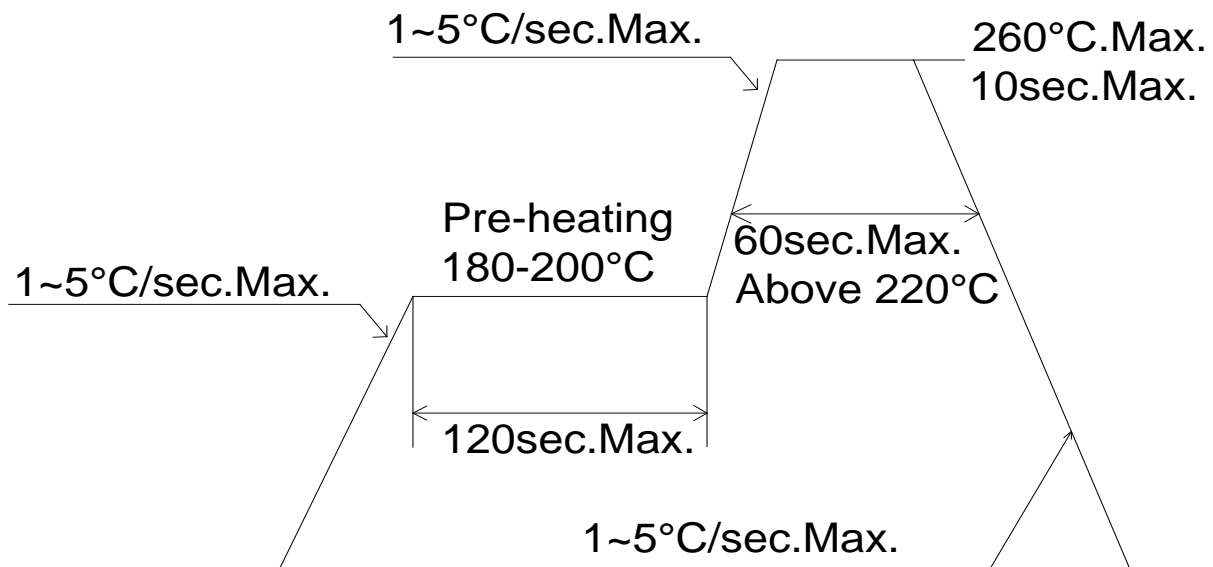

Cautions :**welding**

1. SMD LED is soft and easy to damage the luminous surface and plastic shell by external force.
It should be handled lightly when welding
2. It is recommended to use soldering flux with tin wash type, reflow soldering according to the condition of reflux curve, reflow twice at most, ensure the LED luminous surface is clean, foreign matter will affect the luminous color.
3. Manual welding is only recommended for repair and heavy industry; The maximum welding temperature should not exceed 300 degrees, and must be completed within 3 seconds (manual welding can only be welded once) soldering iron maximum power should not exceed 25W.
4. During the soldering process, do not touch the lens at high temperature, After soldering, any mechanical force on the lens or any excessive vibration shall not be accepted to apply, also the circuit board shall not be bent as well.
5. Please do not use different BIN LED on the same product, otherwise it may cause serious color difference.

cleaning

1. No ultrasonic cleaning. It is recommended to use isopropyl alcohol, pure alcohol to wipe or soak, not more than 1 minute, and leave at room temperature for 15 minutes before use. After cleaning, make sure the LED luminous surface is clean and the foreign matter will affect the luminous color.
2. LED. Avoid touching or contaminating the water, trichloroethylene, acetone, sulfide, nitride, acid, alkali, and salts that can damage leds

embedment

1. Volatile substances to leach into the LED inside, photons in electricity and heat conditions, will lead to the LED color, thus causing serious droop, it is forbidden to use any of the LED device performance or reliability of harmful substances or materials, for a specific purpose and use of the environment, advice on all the material and the material compatibility test. When attaching LED, do not use adhesive that can produce volatile organic gas.
2. It is recommended to light up for 168 hours at room temperature for a small amount of test before using normal filling and sealing glue.

save

1. Before opening the package, LED should be stored in a temperature 30 °C or below, under RH60 % relative humidity, used in a year.
2. LED is humidity sensitive element, element to avoid moisture absorption, after open the packing, the LED should be in temperature 30 °C or below, within 60% relative humidity, using time 7 days. After moisture absorption, LED may crack when reflow soldering, influence the luminous color. For bulk is not used, please deal with the tide (for package product: bake 60 °C +/- 5 °C / 24 h. For bulk goods: baking 105 °C + 5 °C, 1 hours), and then save after sealed with aluminum foil bag or stored in nitrogen moistureproof enclosure
3. Avoid the presence of acid, alkali and corrosive gas in the preservation environment, and avoid strong vibration and strong magnetic field.

electrostatic

1. Static electricity or peak surge voltage will damage the LED, avoiding instantaneous voltage when the lamp is turned on or off.
2. It is recommended to wear anti-static wrist bands, anti-static gloves and anti-static shoes when using LED. The equipment and instruments used are properly grounded. After the LED was damaged, the leakage current increased obviously, the forward voltage of low current became lower, and the low current point did not light, etc

test

- LED shall be driven at rated current, and shall be protected by current-limiting resistance in the circuit. Otherwise, slight voltage changes will cause large current changes, which will damage the LED.
- When the circuit is on or off, avoid sudden surge voltage. Otherwise, the LED will be burnt out

Please check the LED as shown

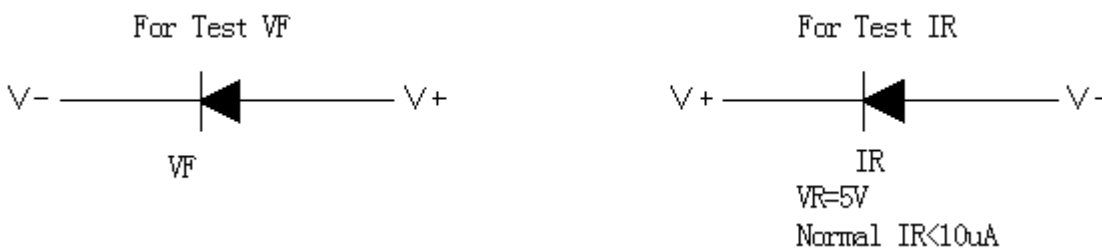

- If the forward voltage VF is too high or the reverse voltage VR is too high, the LED will be damaged.
- When lighting or testing the LED, the reverse voltage added on both ends of the LED shall not be higher than 5V, otherwise it is easy to damage the LED
- LED luminous color will vary slightly with the working current. It is suggested that resistance and LED should be used in series in the design

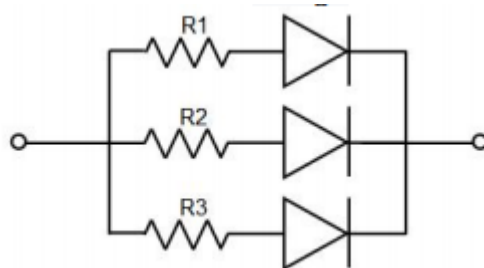

- LED is easy to change due to its own heat and changes in the temperature of the environment. The increase in temperature will reduce the luminous efficiency of LED, which will affect the luminous color. Heat dissipation should be fully considered in the design