



**PARA LIGHT ELECTRONICS CO., LTD.**  
11F, No.8, Jiankang Rd,Zhonghe Dist,New Taipei City 235, Taiwan  
Tel: 886-2-2225-3733 Fax: 886-2-2225-4800  
E-mail: [para@para.com.tw](mailto:para@para.com.tw) http:// [www.paralighttaiwan.com](http://www.paralighttaiwan.com)

## DATA SHEET

PART NO. : LC19DKYCT-XG

REV : A/1

CUSTOMER'S APPROVAL : \_\_\_\_\_ DCC : \_\_\_\_\_

DRAWING NO. : DS-51-21-036

DATE : 2021-11-27

Page : 1

## PACKAGE DIMENSIONS

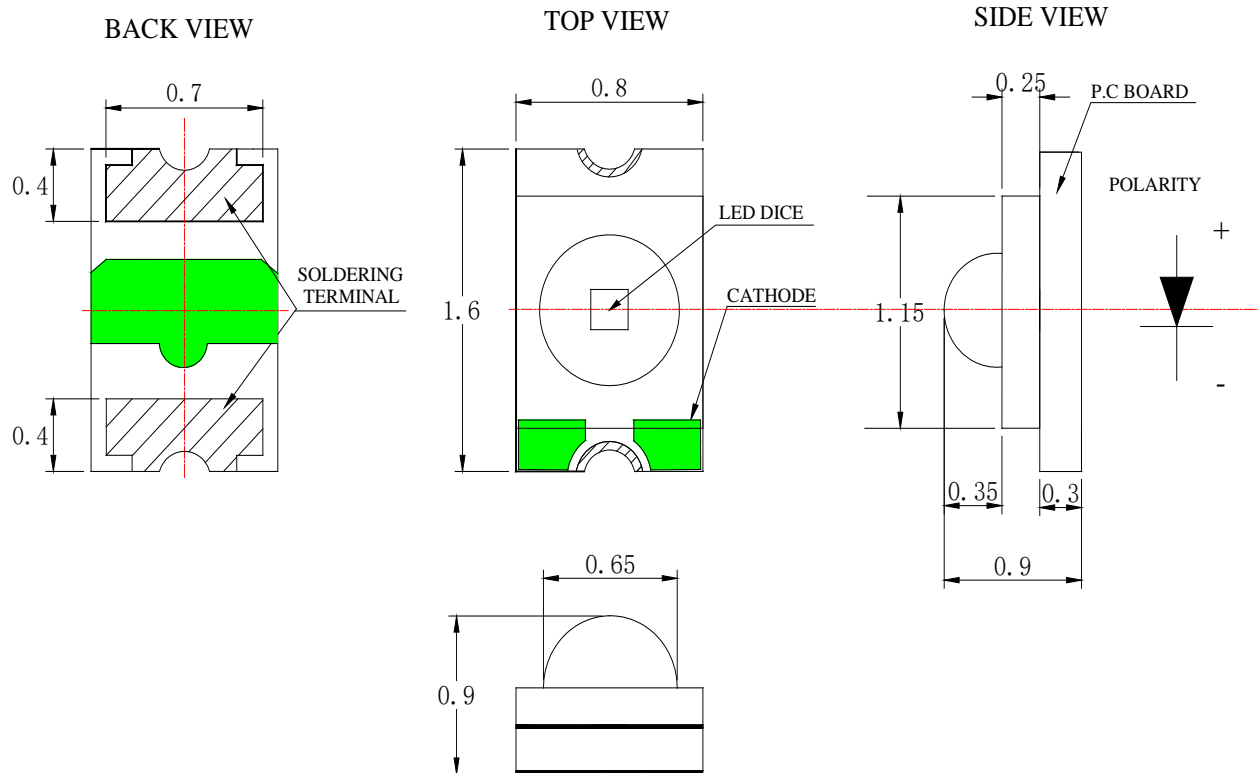

## NOTES :

- 1.All dimensions are in millimeters
- 2.Tolerances are  $\pm 0.2$ mm unless otherwise noted
- 3.The Specifications in the datasheet are subject to change without notice.



1.6\*0.8\*0.9 mm SMD LED

LC19DKYCT-XG

REV:A/1

### FEATURES

Dimension (L / w / h): 1.6 x 0.8 x 0.9 mm

Color: yellow light

Colloid: transparent spherical colloid

EIA standard packaging

Environmental protection products meet ROHS requirements

Suitable for automatic placement machine

Suitable for infrared reflow soldering process

ABSOLUTE MAXIMUM RATING : ( Ta = 25°C )

Symbol	Parameter	Rating	Unit
PD	Power consumption	60	mW
If	Forward Current	20	mA
Ifp	Peak Forward Current (1/10 duty cycle 0.1ms)	70	mA
VR	Reverse Voltage	5	V
ESD	Electrostatic discharge (HBM)	2000	V
Topr	Operating Temperature Range	-30°C ~ + 85°C	°C
Tstg	Storage Temperature Range	-40°C ~ + 90°C	°C
Tsol	Reflow soldering : 255°C ,10s, Hand soldering : 300°C ,3s		

Note: Pulse width  $\leq 0.1$ ms,Duty $\leq 1/10$

ELECTRO-OPTICAL CHARACTERISTICS : ( Ta = 25°C )

Parameter	Symbol	Min.	Typ.	Max.	Unit	Test Condition
Luminous Intensity	Iv	300	500	700	mcd	IF=20mA
Viewing Angle	2 $\theta$ 1/2	-	60	-	deg	IF=20mA
Dominant Wavelength	WD	587	593	596	nm	IF=20mA
Forward Voltage	VF	1.8	2.0	2.2	V	IF=20mA
Reverse Current	IR	-	-	5	$\mu$ A	VR=5V



1.6\*0.8\*0.9 mm SMD LED

LC19DKYCT-XG

REV:A/1

● Bin Code List

Parameter	Symbol	Min.	Max.	Unit	Test Condition
Luminous Intensity	IV	300	380	mcd	IF =20mA
		380	500		
		500	700		
Forward Voltage	VF	1.8	2.0	V	IF =20mA
		2.0	2.2		
Dominant Wavelength	WD	587	590	nm	IF =20mA
		590	593		
		593	596		

Label marking error:

1. Tolerance of measurement of luminous intensity is  $\pm 20\%$ .
2. Tolerance of measurement of dominant wavelength is  $\pm 1\text{nm}$ .
3. Tolerance of measurement of Vf is  $\pm 0.1\text{ V}$ .

Typical Electro-Optical Characteristics Curves

Relative Intensity VS wavelength

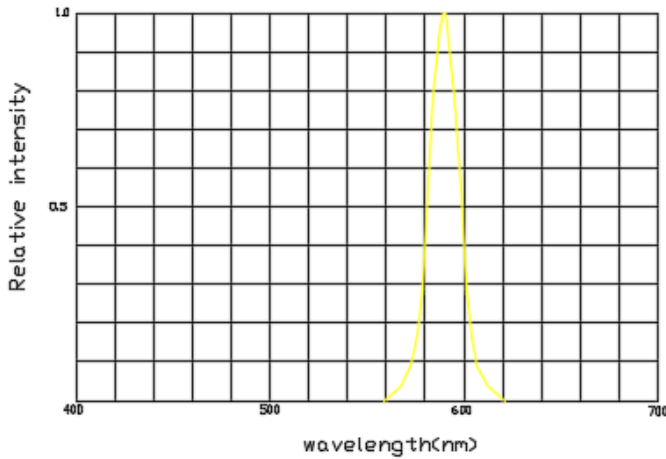

Voltage current relationship

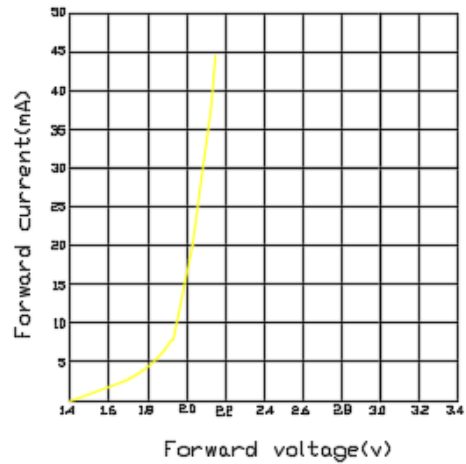

Current and ambient temperature

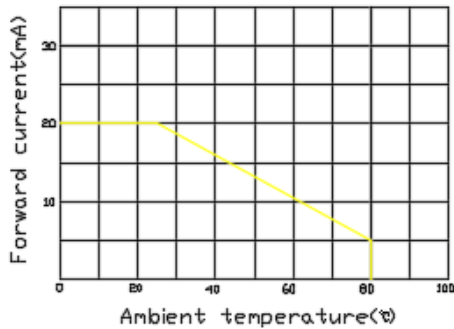

Relative light intensity vs current

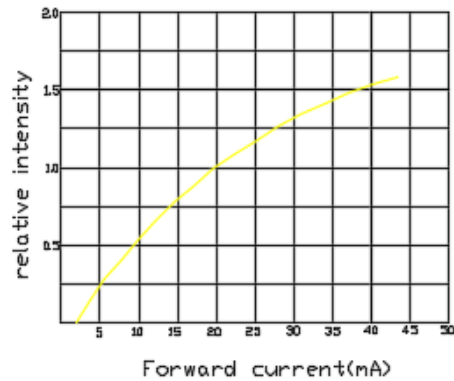

Relative light intensity vs ambient temperature

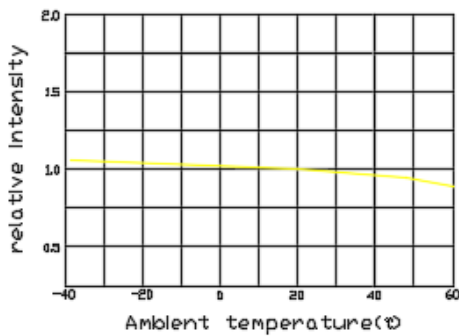

Radiation angle

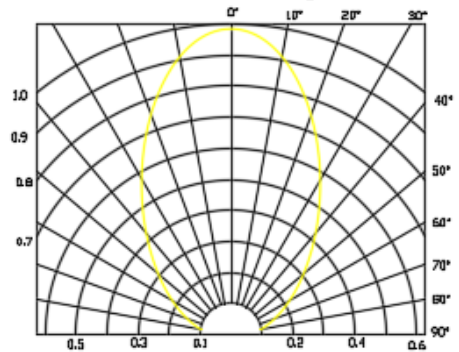

● Reel Dimensions

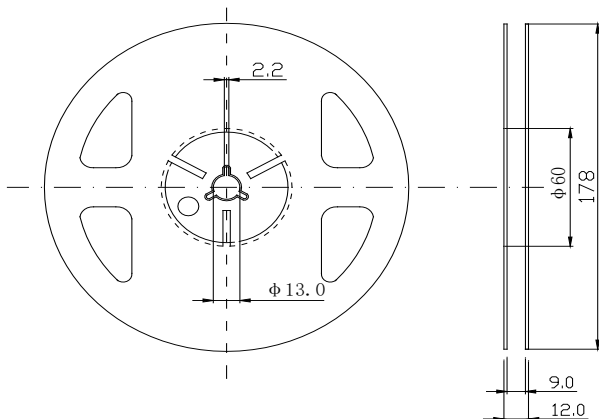

● Package Dimensions Of Tape And Reel

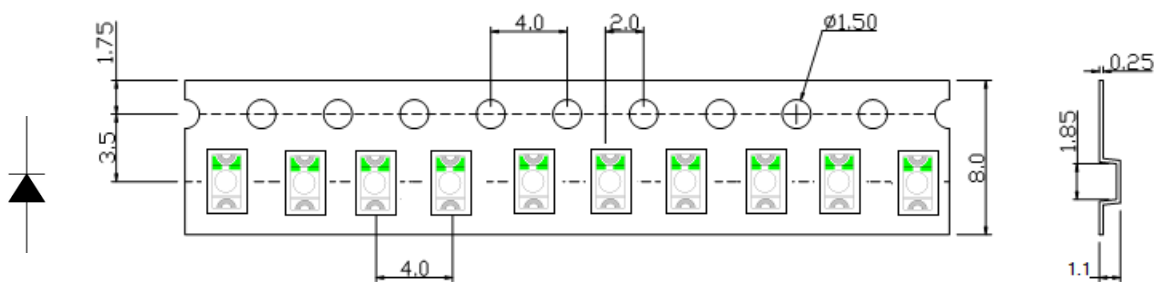

Notes:

1. Taping Quantity : 4000pcs
2. The tolerances unless mentioned is  $\pm 0.15$ mm

Recommended reflow temperature curve

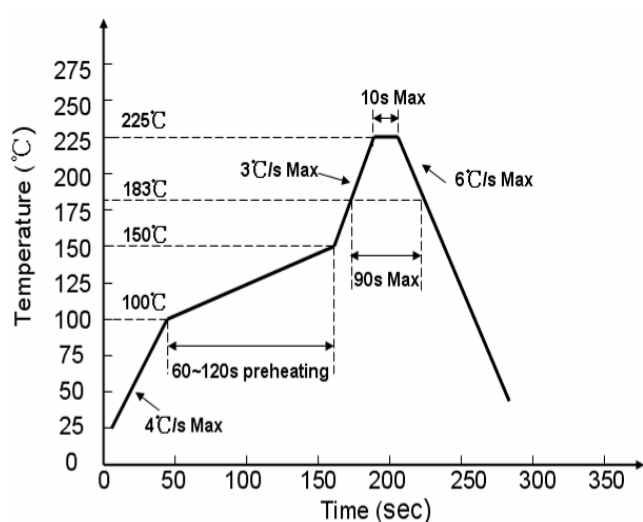

PB

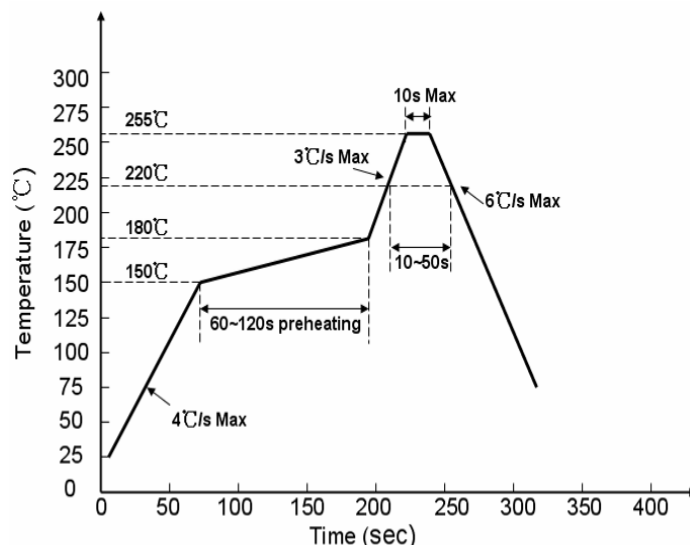

PB FREE



1.6\*0.8\*0.9 mm SMD LED

LC19DKYCT-XG

REV:A/1

**Reliability Test Items And Conditions**

Items	Test Condition	Test Hours/Cycles	Quantity	Ac/Re
Moisture proof grade	1. Reflow soldering maximum temperature = 260 °C, 10 seconds, twice reflow soldering; 2. Storage condition before reflow soldering: 30 °C, relative humidity = 70%, 168h;	-	22 PCS	0/1
Reliability of welding (lead free)	Reflow soldering maximum temperature = 245 ± 5 °C, 5 seconds (lead free reflow soldering)	-	22PCS	0/1
Thermal Shock	H : +85°C 15min. conversion time is 3 minutes L : -35°C 15min.	300Cycles	22PCS	0/1
High Temperature Storage	Temp. : 100°C	1000Hrs	22PCS	0/1
Low Temperature Storage	Temp. : -40°C	1000Hrs	22PCS	0/1
Room temperature aging	Ta=25°C IF=20mA	1000Hrs	22PCS	0/1
Thermal cycling	-40 °C 30 min ~ 25 °C 5 min~ 100 °C 30 min ~ 25 °C 5 min	300Cycles	22PCS	0/1

**Failure Criteria**

Test Items	Symbol	Test condition	Failure Criteria	
			Min.	Max.
Forward Voltage	VF	IF=20mA	---	(U.S.L*)×1.1
Reverse Current	IR	VR=5V	---	(U.S.L*)×2.0
Luminous Intensity	Iv	IF=20mA	(L.S.L*)×0.7	---

Notes:1.U.S.L means the upper limit of specified characteristics.

2.Measurment shall be taken between 2 hours and after the test pieces have been returned normal ambient conditions after completion of each test.



1.6\*0.8\*0.9 mm SMD LED

LC19DKYCT-XG

REV:A/1

## Cautions

### Use

1 High temperature will affect the brightness and other performance of LED, so in order to make LED have better performance, it is necessary to keep led away from heat source.

### Storage

1. Before opening original package, it is recommended to store them in the following environment: Temperature: 5°C~30°C/Humidity: 60%RH max; When stock exceeds two months, dehumidification should be done before use at 60 C/8 hours.
2. After opening original package, the storage ambient for the LEDs should be in 5~30°C temperature and 60% or less relative humidity.
3. In order to avoid moisture absorption, it is recommended that the LEDs that out of the original package should be stored in a sealed container with appropriate desiccant, or in desiccators with nitrogen ambient.
4. The LEDs should be used within 168hrs (7 days) after opening the package. Once been mounted, soldering should be quick.
5. If the moisture absorbent material (silica gel) has faded away or the LEDs stored out of original package for more than 168hrs (7 days), baking treatment should be performed using the conditions: 60°C at least 24 hours.

### ESD (Electrostatic Discharge )-Protection

A LED (especially the Blue、 White and Green product) is an ESD sensitive component, and static electricity or power surge will damage the LED. ESD-damaged LEDs will exhibit abnormal characteristics such as high reverse leakage current, low forward voltage, or “no light-up” at low currents, etc.

Some advice as below should be noticed:

1. A conductive wrist strap or anti-electrostatic glove should be worn when handling these LEDs.
2. All devices, equipment, machinery, work tables and storage racks, etc. must be properly grounded.
3. Use anti-static package or boxes to carry and storage LEDs. And ordinary plastic package or boxes is forbidden to use.
4. Use ionizer to neutralize the static charge during handling or operating.

### Cleaning

Use alcohol-based cleaning solvents such as IPA (isopropyl alcohol) to clean LEDs if necessary.





1.6\*0.8\*0.9 mm SMD LED

LC19DKYCT-XG

REV:A/1

### **Welding**

- 1.Refer to the temperature curve on page 1 for reflow welding conditions;
- 2.The number of reflow soldering shall not exceed two times;
- 3.It is only recommended to use manual welding in the case of repair and heavy work. The maximum welding temperature should not exceed 300 °C and should be completed within 3 seconds.
- 4.The maximum power of soldering iron shall not exceed 30W;
- 5.During welding, it is forbidden to touch colloid at high temperature; after welding, it is forbidden to apply external force on colloid and bend PCB to avoid damage to components to hit.

### **Other**

- 1.The definition of LED described in this specification shall be used in the scope of common electronic equipment (such as office equipment, communication equipment, etc.). If there is more severe Especially when the component failure or failure may directly endanger life and health (such as aerospace, transportation, transportation, medical treatment) Equipment, safety protection, etc.), please inform our business personnel in advance;
- 2.When high brightness LED products are on, it may cause damage to human eyes, so it is necessary to avoid looking directly at them from above;
- 3.For the purpose of continuous improvement, product appearance and parameter specifications may be changed without prior notice.