



**PARA LIGHT ELECTRONICS CO., LTD.**  
11F, No.8, Jiankang Rd,Zhonghe Dist,New Taipei City 235, Taiwan  
Tel: 886-2-2225-3733 Fax: 886-2-2225-4800  
E-mail: [para@para.com.tw](mailto:para@para.com.tw) http:// [www.paralighttaiwan.com](http://www.paralighttaiwan.com)

## DATA SHEET

PART NO. : LS193JYCT-5A-XG

REV : A / 0

CUSTOMER'S APPROVAL : \_\_\_\_\_ DCC : \_\_\_\_\_

DRAWING NO. :DS-51-22-101

DATE : 2023-01-10

Page : 1

PACKAGE DIMENSIONS

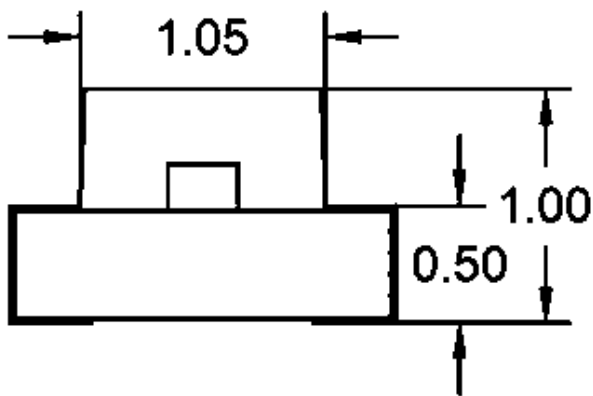
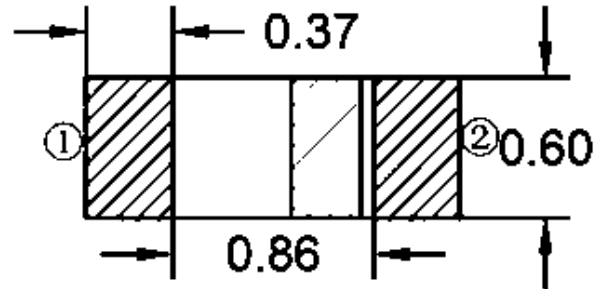
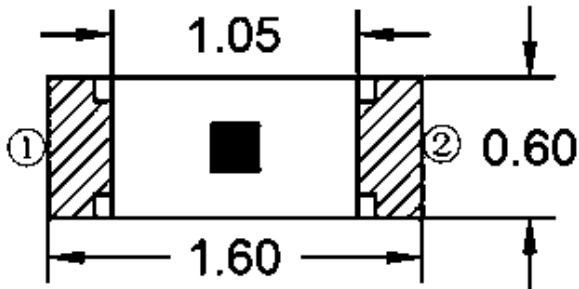

Recommended pad size

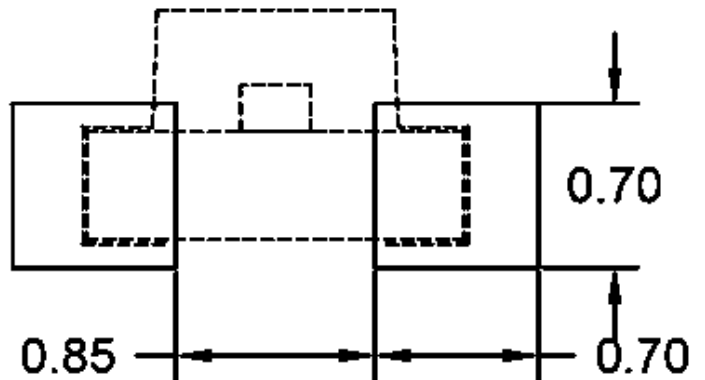

NOTES :

- 1.All dimensions are in millimeters
- 2.Tolerances are  $\pm 0.15$ mm unless otherwise noted
- 3.The Specifications in the datasheet are subject to change without notice.



1.6 x 0.6 x 1.0mm SMD LED

LS193JYCT-5A-XG

REV:A / 0

### FEATURES

Dimension (L / w / h): 1.6 x 0.6 x 1.0mm

Color: Yellow light

Colloid: Transparent colloid

EIA standard packaging

Environmental protection products meet ROHS requirements

Suitable for automatic placement machine

Suitable for infrared reflow soldering process

### ABSOLUTE MAXIMUM RATING : ( Ta = 25°C )

Symbol	Parameter	Rating	Unit
PD	Power consumption	65	mW
If	Forward Current	25	mA
Ifp	Maximum pulse current (1/10 duty cycle 0.1ms)	80	mA
VR	Reverse Voltage	5	V
ESD	Electrostatic discharge	1500	V
Topr	Operating Temperature Range	-40°C ~ + 85°C	°C
Tstg	Storage Temperature Range	-40°C ~ + 85°C	°C
Tsol	Reflow soldering : 255°C ,10s, Hand soldering : 300°C ,3s		

Note: Pulse width  $\leq 0.1$ ms,Duty $\leq 1/10$

### ELECTRO-OPTICAL CHARACTERISTICS : ( Ta = 25°C )

Parameter	Symbol	Min.	Typ.	Max.	Unit	Test Condition
Luminous Intensity	Iv	20	-	75	mcd	IF=5mA
Viewing Angle	2 $\theta$ 1/2	-	120	-	deg	IF=5mA
Dominant Wavelength	WD	587	-	596	nm	IF=5mA
Forward Voltage	VF	1.7	-	2.3	V	IF=5mA
Reverse Current	IR	-	-	10	$\mu$ A	VR=5V

● Bin Code List

Parameter	Symbol	Min.	Max.	Unit	Test Condition
Luminous Intensity	IV	20	28	mcd	IF =5mA
		28	39		
		39	55		
		55	75		
Forward Voltage	VF	1.7	1.9	V	IF =5mA
		1.9	2.1		
		2.1	2.3		
Dominant Wavelength	WD	587	590	nm	IF =5mA
		590	593		
		593	596		

Label marking error:

1. Tolerance of measurement of luminous intensity is  $\pm 20\%$ .
2. Tolerance of measurement of dominant wavelength is  $\pm 2\text{nm}$ .
3. Tolerance of measurement of Vf is  $\pm 0.1\text{ V}$ .

Typical Electro-Optical Characteristics Curves

Relative intensity vs wavelength

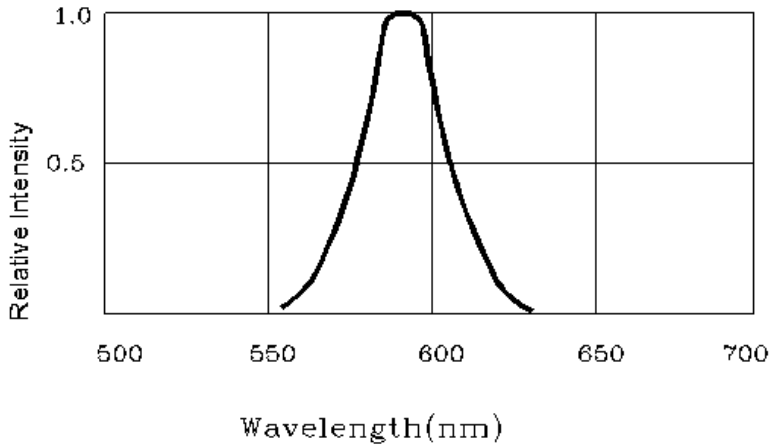

Voltage current relationship

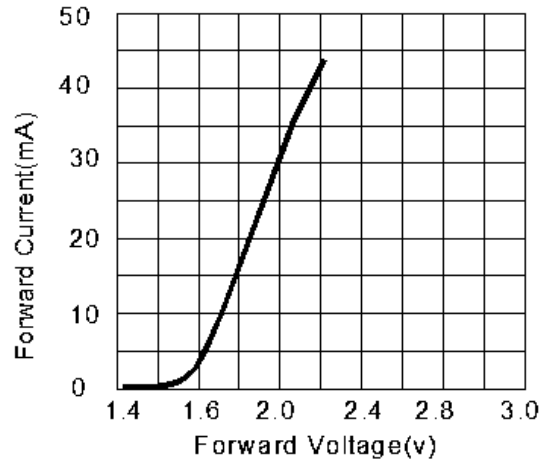

Current and ambient temperature

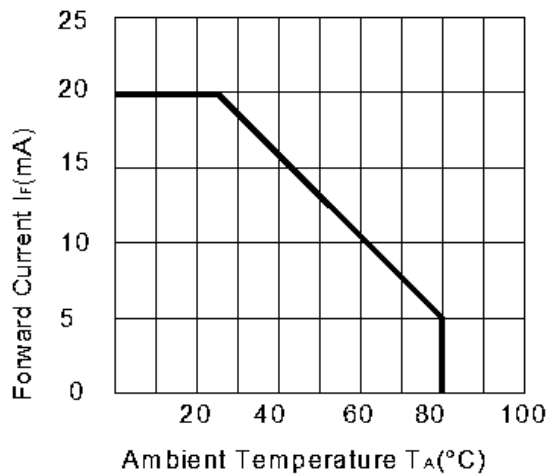

Relative light intensity vs current

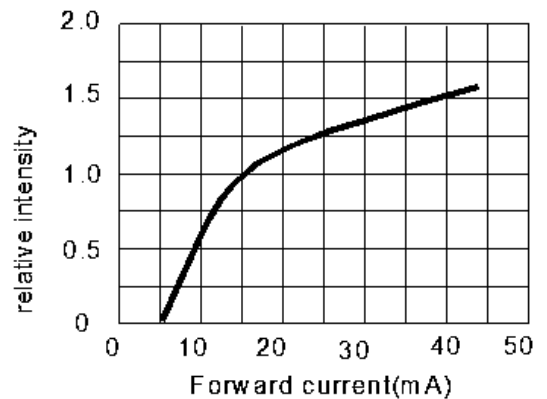

Relative light intensity vs ambient temperature

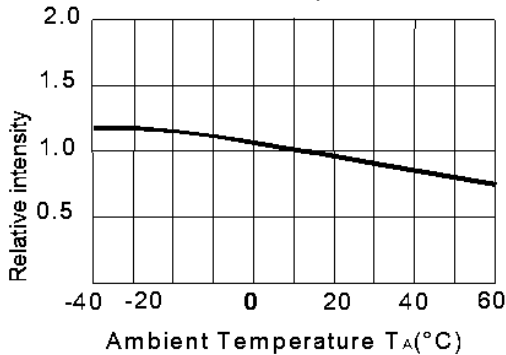

Radiation angle

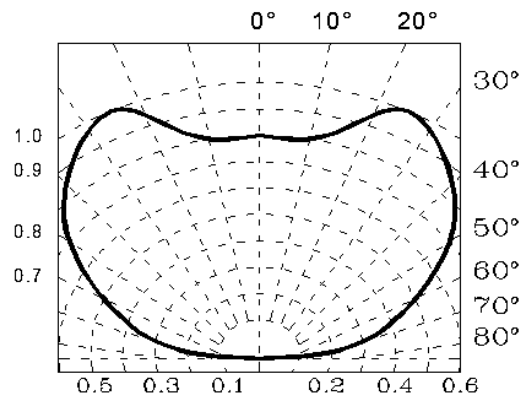

● Reel Dimensions

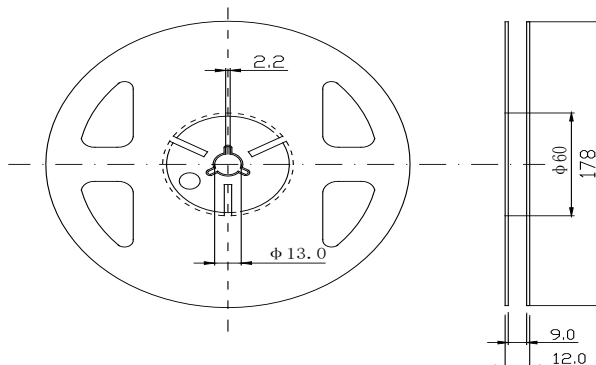

● Package Dimensions Of Tape And Reel

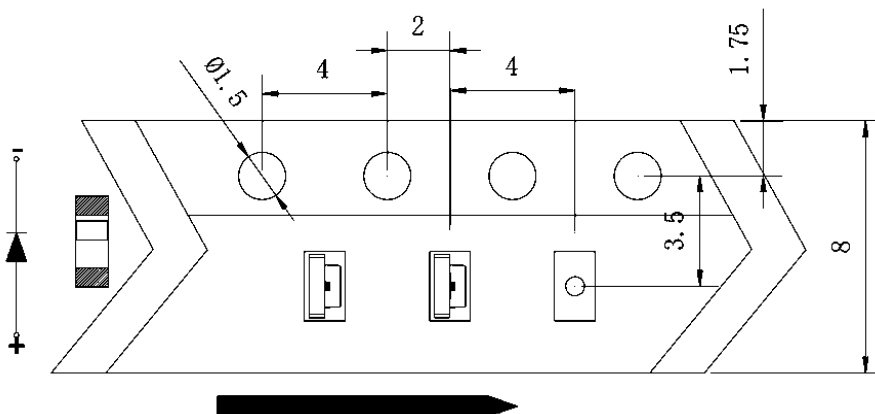

Notes:

1. Taping Quantity : 4000pcs
2. The tolerances unless mentioned is  $\pm 0.15$ mm

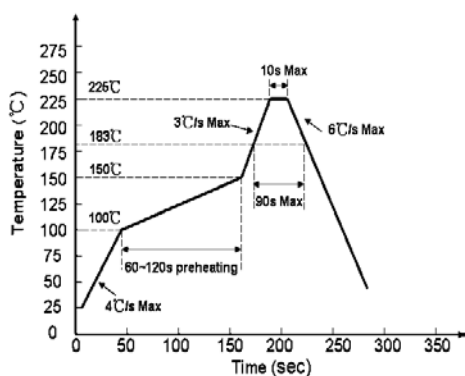

PB

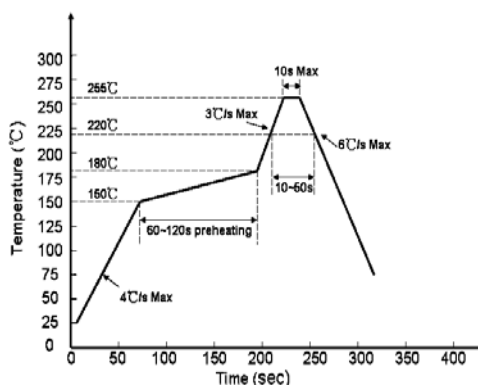

PB FREE



1.6 x 0.6 x 1.0mm SMD LED

LS193JYCT-5A-XG

REV:A / 0

Reliability Test Items And Conditions

number	Test Item	Ref.Standard	Test Conditions	Note	Conclusion
1	Reflow Soldering	JESD22-B106	Tsld=260°C,10sec	3 times	0/20
2	Temperature Cycle	JESD22-A104	85°C(30Min)~25°C (5min) ~-40°C(30Min)	300 cycle	0/20
3	Thermal Shock	JESD22-A106	-40°C (15Min) ~115°C (15Min)/ Switching time 5Min	200 cycle	0/20
4	High Temperature Storage	JESD22-A103	Ta=100°C	1000 hrs	0/20
5	Low Temperature Storage	JESD22-A119	Ta=-40°C	1000 hrs	0/20
6	Life Test	JESD22-A108	Ta=25°C IF=20mA	1000 hrs	0/20
7	Pulsed Operating Life	Enterprise standards	IFP = specification design, pulse width≤ 10ms, duty cycle ≤10%, high temperature energized pulse test (100±5°C-20mA-pulse 2.0HZ)	168hrs	0/20
8	Double 85 Aging attenuation experiment	Enterprise standards	85±5°C/85±5%RH;	1000hrs	0/20

Failure Criteria

Standard#	project	Test	Failure criteria
# 1	Forward voltage (VF)	IF=5mA	>U.S.L*1.1
	Light intensity (IV)	IF=5mA	<L.S.L*0.7
	Reverse Current (IR)	VR=5V	>U.S.L*2.0
# 2	Welding reliability	/	Less than 95% of solder paste covers pads

Notes:1.U.S.L means the upper limit of specified characteristics.

2.Measurment shall be taken between 2 hours and after the test pieces have been returned normal ambient conditions after completion of each test.

● Cautions

use

- LED is a current driven component, the slight change of voltage will produce large current fluctuation, which will lead to component damage.  
The customer should use resistance series as current limiting protection.
- In order to ensure the color consistency of multiple LEDs in parallel, it is recommended to use a separate resistor for each branch, as shown in mode a below;  
If the circuit shown in mode B below is used, the LED light color may be different due to the different volt ampere characteristics of each LED

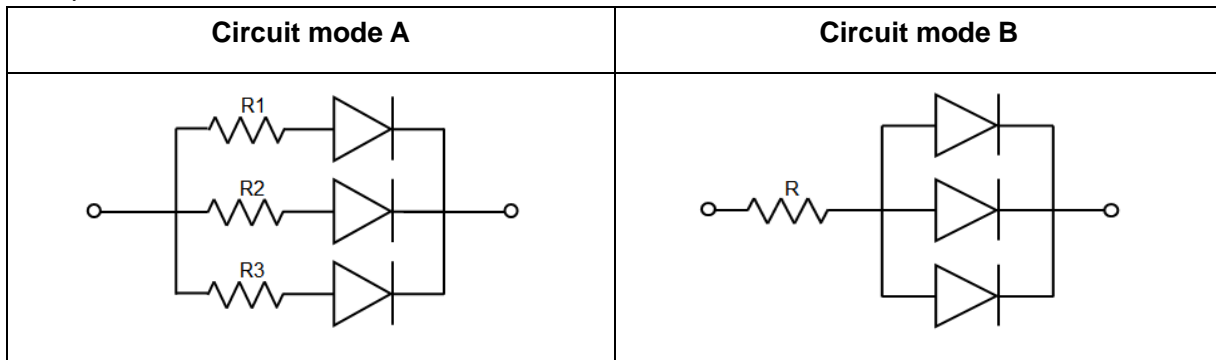

- Too high temperature will affect the brightness and other performance of LED, so in order to make the LED have better performance, we should keep the led away from heat source

**Storage**

- Without opening the original package, the recommended storage environment is: temperature 5 °C ~ 30 °C, humidity below 85% RH. When inventory exceeds two months, Dehumidification should be carried out before use at 60 °C / 8 hours
- After opening the original package, the recommended storage environment is: temperature 5 ~ 30 °C, humidity below 60%
- LED is a humidity sensitive element. In order to avoid moisture absorption, it is recommended to store the LED in a sealed container with desiccant or in a nitrogen moisture-proof cabinet after opening the package
- After unpacking, the components should be used within 168 hours (7 days); and the welding should be completed as soon as possible after placement
- If the desiccant fails or the element is exposed to air for more than 168 hours (7 days), dehumidification should be performed, Baking conditions: 60 °C / 24 hours

**ESD (Electrostatic Discharge )-Protection**

A LED (especially the Blue、 White and Green product) is an ESD sensitive component, and static electricity or power surge will damage the LED. ESD-damaged LEDs will exhibit abnormal characteristics such as high reverse leakage current, low forward voltage, or “no light-up” at low currents, etc.

Some advice as below should be noticed:

- A conductive wrist strap or anti-electrostatic glove should be worn when handling these LEDs.
- All devices, equipment, machinery, work tables and storage racks, etc. must be properly grounded.





1.6 x 0.6 x 1.0mm SMD LED

LS193JYCT-5A-XG

REV:A / 0

3. Use anti-static package or boxes to carry and storage LEDs. And ordinary plastic package or boxes is forbidden to use.
4. Use ionizer to neutralize the static charge during handling or operating.

### Cleaning

Use alcohol-based cleaning solvents such as IPA (isopropyl alcohol) to clean LEDs if necessary.

### Welding

- 1.Refer to the temperature curve on page 1 for reflow welding conditions;
- 2.The number of reflow soldering shall not exceed two times;
- 3.It is only recommended to use manual welding in the case of repair and heavy work. The maximum welding temperature should not exceed 300 °C and should be completed within 3 seconds.
- 4.The maximum power of soldering iron shall not exceed 30W;
- 5.During welding, it is forbidden to touch colloid at high temperature; after welding, it is forbidden to apply external force on colloid and bend PCB to avoid damage to components to hit.

### Other

- 1.The definition of LED described in this specification shall be used in the scope of common electronic equipment (such as office equipment, communication equipment, etc.). If there is more severe Especially when the component failure or failure may directly endanger life and health (such as aerospace, transportation, transportation, medical treatment) Equipment, safety protection, etc.), please inform our business personnel in advance;
- 2.When high brightness LED products are on, it may cause damage to human eyes, so it is necessary to avoid looking directly at them from above;
- 3.For the purpose of continuous improvement, product appearance and parameter specifications may be changed without prior notice.