



PARA LIGHT ELECTRONICS CO.,LTD

11F.,No.8,Jiankang Rd.,Zhonghe Dist.,New Taipei City 235,Taiwan,

Tel: 886-2-2225-3733

Fax: 886-2-2225-4800

Mail:para@para.com.tw Website: http:// www.paralighttaiwan.com

Data Sheet 規格書

LED 燈條

Product Name :LED Light Bar

Model Number: PL-25WLBWWDT-12V-S77

Version: A /0

Producer: 闫红春 Auditing: Approval:

FEATURES/特點:

- ※ Semiconductor light-emitting principle of power-saving.
半導體發光節電原理。
- ※ Long life, More than 20,000 hours.
長壽命，超過20000小時。
- ※ RoHS compliant.
符合RoHS標準。
- ※ IP=68

PURPOSE/目的:

- ※ Backlight illumination
背光照明

APPLICATION/應用:

- ※ Wide range of applications, For civil, commercial or industry BL use.
應用範圍廣，民用，商用或工業用。

ENVIRONMENTAL CONDITION/環境條件:

- ※ The environmental condition as below /所述環境條件如下

Item/項目	Condition/條件	Notes/備註
Operation Temperature / 工作溫度[°C]	-30~+85	
Operation Humidity / 工作濕度[%]	5~60	
Storage Temperature / 儲存溫度[°C]	-30~+85	
Storage Humidity / 儲存濕度 [%]	5~75	

※ Product Diagram/產品示意图:

Photo/圖片

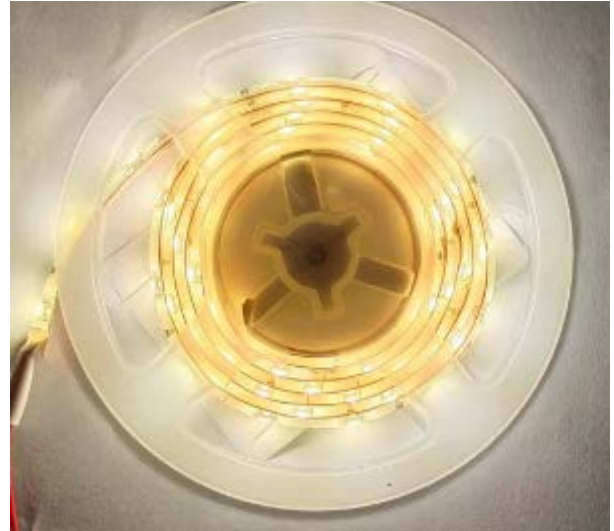

※ Product Specification/產品規格:



- Note/備註:

1. All dimension unit is millimeters

所有尺寸單位為毫米



LED Light Bar / LED 燈條

PL-25WLBWWDT-12V-S77

Version: A/0

※ Layout / 布局

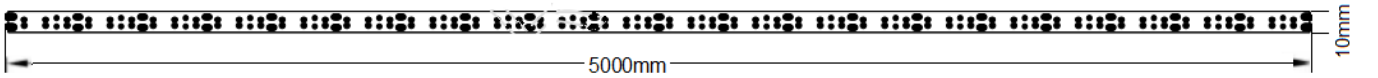

※ Technical parameters/技術參數

Input Voltage Range / 輸入電壓	DC12V±10%
LED Type / 光源類型	2835
LED Quantity / 光源數量	300pcs/5 米
Current / 電流	550mA±10%
Power consumption / 消耗功率	25W±10%
Power Factor / 功率因數	/
Color Temperature / 色溫	3500k±300
Luminous Flux / 光通量	300Lm-600Lm / 5 米
Light Source Life Span / 壽命	>20000 Hrs

※ Package Outline Dimensions 外型尺寸图

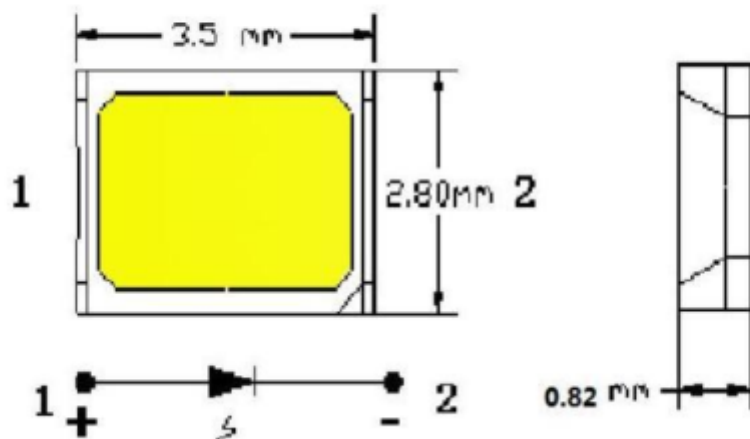

TYPICAL OPTICAL CHARACTERISTICS CURVES 典型光电特性曲线

Spectral Distribution

Relative Intensity VS.
Wavelength (Ta=25°C)

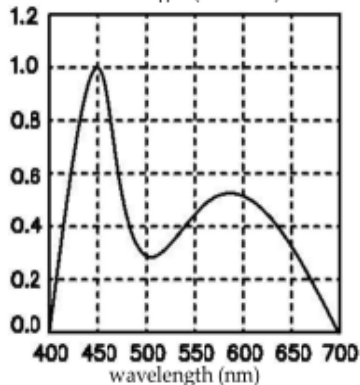

Forward Voltage VS. Forward Current
(Ta=25°C)

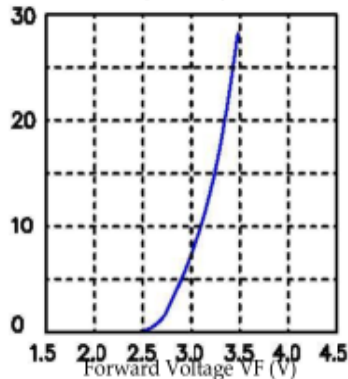

Relative Intensity VS. Forward Current
(Ta=25°C)

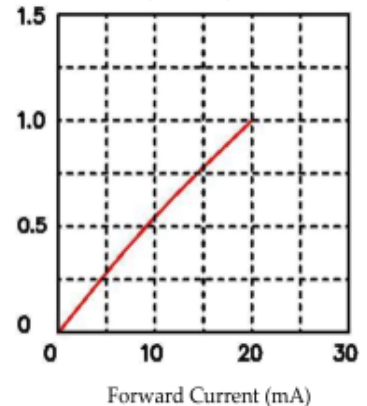

Relative Intensity VS. Ambient Temperature

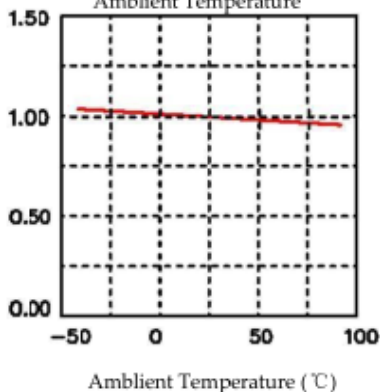

Derating

Ambient Temperature VS.
Maximum Forward Current

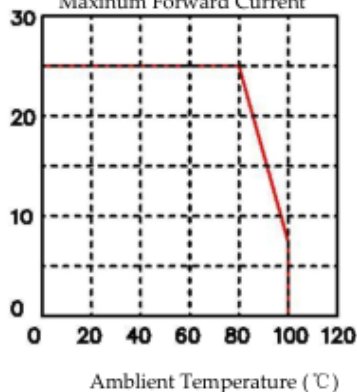

Forward Current VS. Chromaticity
(Ta=25°C)

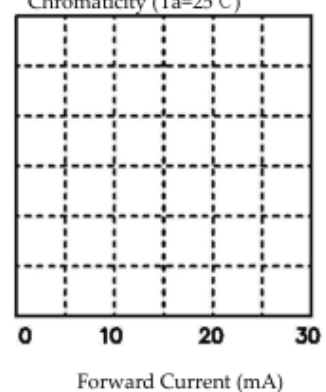
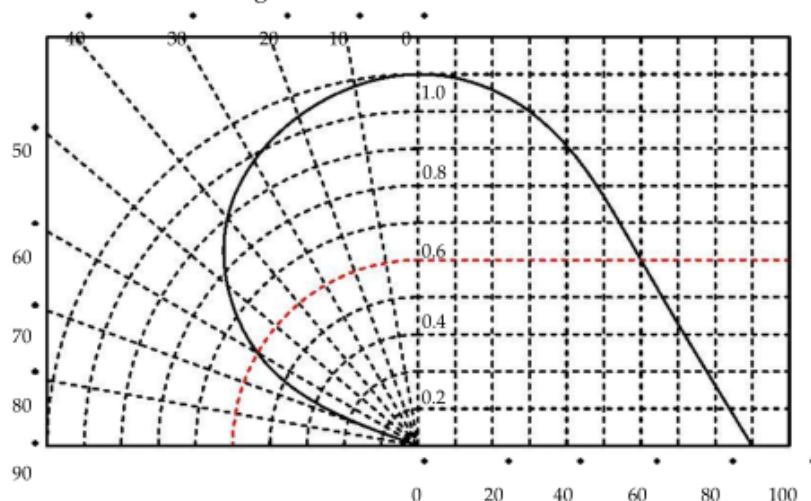
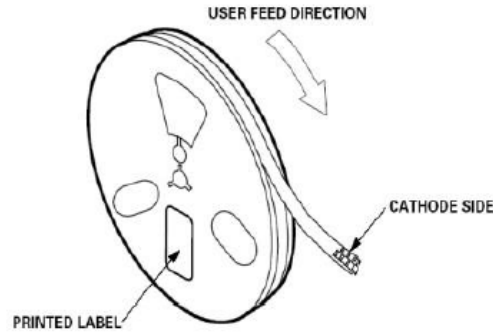

Diagram characteristics of radiation



Packaging Specifications(包装规格):

1、Feeding Direction(进料方向):



2、Packing Icon(包装图标):

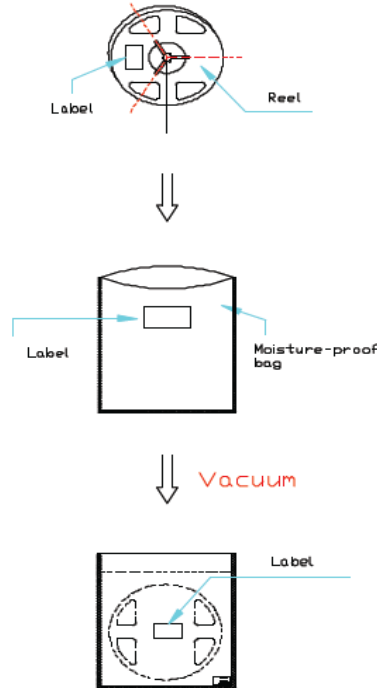

3、标签图



※ Optical Specification/光学规格**1. Measurement Condition/测量条件****1-1 Environmental Temperature: $25 \pm 2^{\circ}\text{C}$** 环境温度: $25 \pm 2^{\circ}\text{C}$ **1-2 Environmental Humidity: $50\% \pm 20\%$** 环境湿度: $50\% \pm 20\%$ **1-3 Environmental Luminance: Less than 10(lx) and windless (Typical)**

环境亮度: 小于 10(lx) 无风 (典型值)

2. Measurement Equipment/测量设备**2-1 Spectroradiometric & Electric Analysis: SP-3000**

光色和电力分析: SP-3000

2-2 The PARA LIGHT inspection result is to be taken as the standard. Before approval, both PARA LIGHT and customer should inspect and correct the optical data measured by PARA LIGHT and customer.

光鼎集团检验结果将作为标准,

批准前, 无论是光鼎和客户应按测量的结果检验并校正光学数据。

3. Measuring means/测量装置