



PARA LIGHT ELECTRONICS CO., LTD.
11F., No. 8, Jiankang Rd., Zhonghe Dist., New Taipei City 235, Taiwan,
Tel: 886-2-2225-3733 Fax: 886-2-2225-4800
E-mail: para@para.com.tw <http://www.para.com.tw>

DATA SHEET

PART NO. : PC75H060AB

REV : A / 0

CUSTOMER'S APPROVAL : _____ DCC : _____

DRAWING NO. : DS-91P-22-0001

DATE : 2023-06-07

Page : 1

Package Dimensions

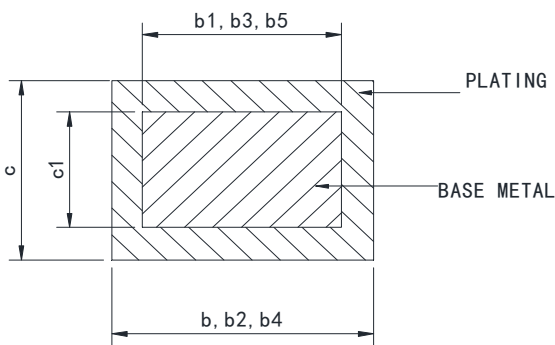
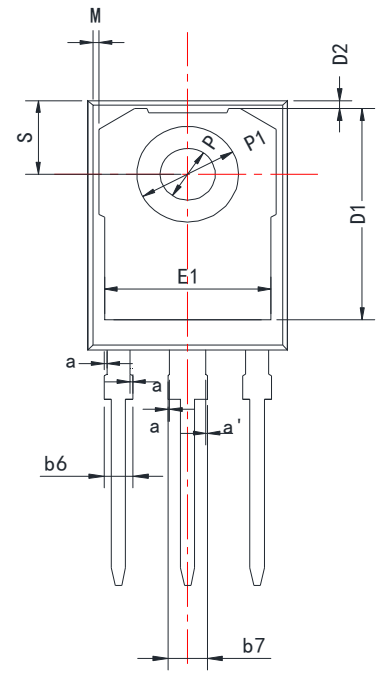
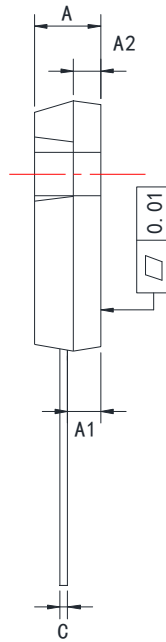
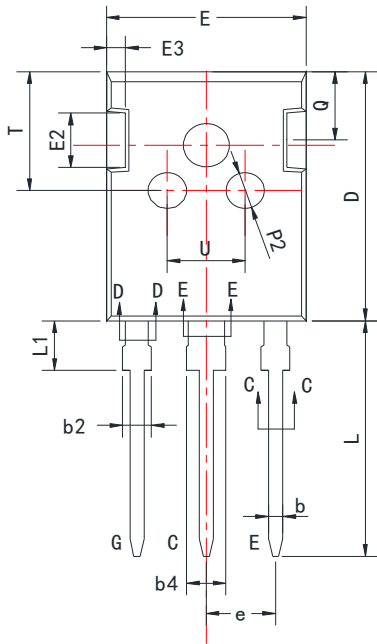

SECTION C-C, D-D&E-E

Common dimensions(mm)

Symbol	Min	Typ	Max	Symbol	Min	Typ	Max
A	4.85	5.0	5.1	D2	1.05	1.17	1.35
A1	2.31	2.41	2.51	E	15.7	15.8	15.9
A2	1.9	2.0	2.1	E1	13.1	13.3	13.5
a	0	-	0.15	E2	4.4	4.5	4.6
a'	0	-	0.15	E3	1.5	1.5	1.7
b	1.16	-	1.26	e	5.436		
b1	1.15	1.2	1.22	L	19.8	19.92	20.1
b2	1.96	-	2.06	L1	-	-	4.3
b3	1.95	2.0	2.02	M	0.35	-	0.95
b4	2.96	-	3.06	P	3.4	3.5	3.6
b5	2.96	3.0	3.02	P1	7.0	-	7.4
b6	-	-	2.25	P2	2.4	2.5	2.6
b7	-	-	3.25	Q	5.6	-	6.0
c	0.59	-	0.66	S	6.05	6.15	6.25
c1	0.58	0.6	0.62	T	9.8	-	10.2
D	20.9	21.0	21.1	U	6.0	-	6.4
D1	16.25	16.55	16.85				

Features

600V, 75A

$V_{CE(sat)(typ.)} = 1.80V @ V_{GE} = 15V, I_C = 75A$

Maximum Junction Temperature 175°C

Pb-free Lead Plating; RoHS Compliant

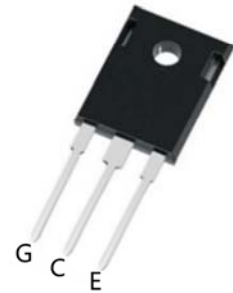
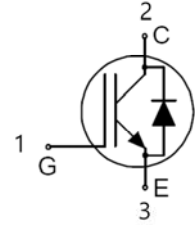

Applications

Solar Converters

Uninterrupted Power Supply

Welding Converters

Mid to High Range Switching Frequency Converters

Key Performance and Package Parameters

V_{CE}	I_C	$V_{CEsat}, T_{vj}=25^{\circ}C$	T_{vjmax}
600V	75A	1.80V	175°C

Absolute Maximum Ratings

Symbol	Parameter	Value	Unit
V_{CES}	Collector-Emitter Voltage	600	V
V_{GES}	Gate-Emitter Voltage	± 20	V
I_C	Continuous Collector Current ($T_C=25^{\circ}C$)	110	A
	Continuous Collector Current ($T_C=100^{\circ}C$)	75	A
I_{CM}	Pulsed Collector Current (Note 1)	300	A
P_D	Maximum Power Dissipation ($T_C=25^{\circ}C$)	385	W
	Maximum Power Dissipation ($T_C=100^{\circ}C$)	192	W
T_J	Operating Junction Temperature Range	-40 to 175	°C
T_{STG}	Storage Temperature Range	-55 to 150	°C

Thermal Data

Symbol	Parameter	Max.	Unit
$R_{\theta JC}$	Thermal Resistance, Junction to Case for IGBT	0.39	°C/W
$R_{\theta JC}$	Thermal Resistance, Junction to Case for Diode	0.46	°C/W
$R_{\theta JA}$	Thermal Resistance, Junction to Ambient	40	°C/W

Electrical Characteristics (Tc=25°C unless otherwise noted.)

Symbol	Parameter	Conditions	Min.	Typ.	Max.	Unit
BV _{CES}	Collector-Emitter Breakdown Voltage	V _{GE} =0V, I _C =200uA	600	---	---	V
I _{CES}	Collector-Emitter Leakage Current	V _{CE} =600V, V _{GE} =0V	---	---	75	uA
I _{GES}	Gate Leakage Current, Forward	V _{GE} =20V, V _{CE} =0V	---	---	100	nA
	Gate Leakage Current, Reverse	V _{GE} =-20V, V _{CE} =0V	---	---	100	nA
V _{GE(th)}	Gate Threshold Voltage	V _{GE} =V _{CE} , I _C =750uA	3.2	4	4.8	V
V _{CE(sat)}	Collector-Emitter Saturation Voltage	V _{GE} =15V, I _C =75A, T _J =25°C	---	1.80	2.20	V
		V _{GE} =15V, I _C =75A, T _J =125°C	---	2.05	---	V
Q _G	Total Gate Charge	V _{CC} =520V	---	115	---	nC
Q _{GE}	Gate-Emitter Charge	V _{GE} =15V	---	31	---	nC
Q _{GC}	Gate-Collector Charge	I _C =75A	---	28	---	nC
t _{d(on)}	Turn-on Delay Time	V _{CC} =400V V _{GE} =±15V I _C =75A R _G =8Ω Inductive Load T _C =25°C	---	27	---	ns
t _r	Turn-on Rise Time		---	82	---	ns
t _{d(off)}	Turn-off Delay Time		---	152	---	ns
t _f	Turn-off Fall Time		---	131	---	ns
E _{on}	Turn-on Switching Loss		---	1.72	---	mJ
E _{off}	Turn-off Switching Loss		---	2.51	---	mJ
E _{is}	Total Switching Loss		---	4.23	---	mJ
C _{ies}	Input Capacitance	V _{CE} =25V	---	3669	---	pF
C _{oes}	Output Capacitance	V _{GE} =0V	---	285	---	pF
C _{res}	Reverse Transfer Capacitance	f = 1MHz	---	38	---	pF
SCSOA	Short Circuit Safe Operation Area	V _{GE} =15V, V _{CC} ≤400V, T _{J,start} ≤25°C	10	---	---	uS

Diode Characteristics (TC=25°C unless otherwise noted)

Symbol	Parameter	Conditions	Min.	Typ.	Max.	Unit
V _F	Diode Forward Voltage	I _F =75A, T _J =25°C	---	1.60	1.80	V
		I _F =75A, T _J =150°C	---	1.42	---	V
t _{rr}	Diode Reverse Recovery Time	VR=400V	---	136	---	ns
I _{rr}	Diode peak Reverse Recovery Current	I _F =75A dI _F /dt=300A/us	---	14.6	---	A
Q _{rr}	Diode Reverse Recovery Charge	T _C =25°C	---	1200	---	nC

Note1: Repetitive rating, pulse width limited by maximum junction temperature

Typical Characteristics

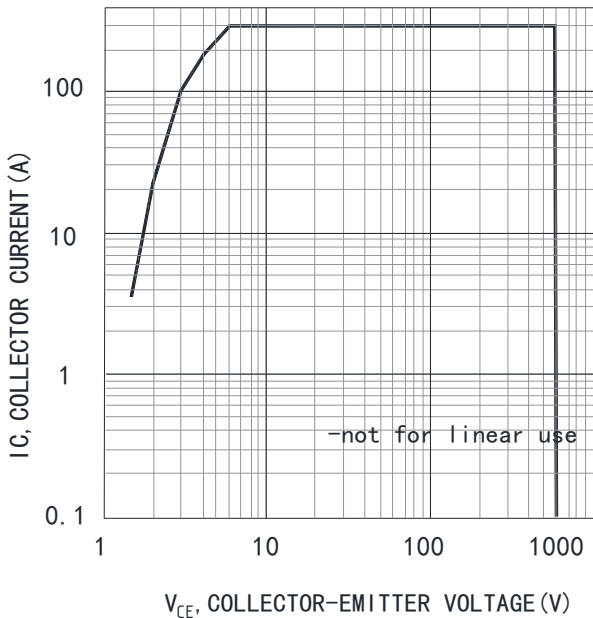

Fig. 1 Forward bias safe operating area (D=0, T_c=25°C, T_{vj}≤175°C; V_{GE}=15V. Recommended use at V_{GE}≥7.5V)

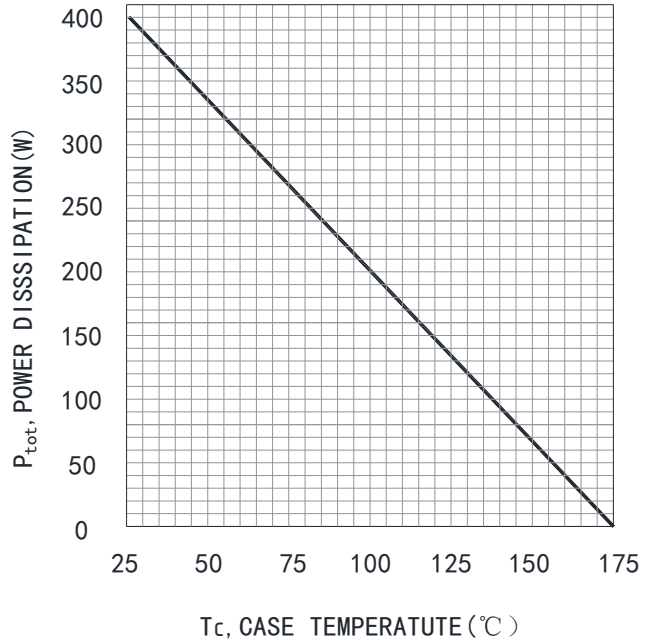

Fig. 2 Power dissipation as a function of case temperature (T_{vj}≤175°C)

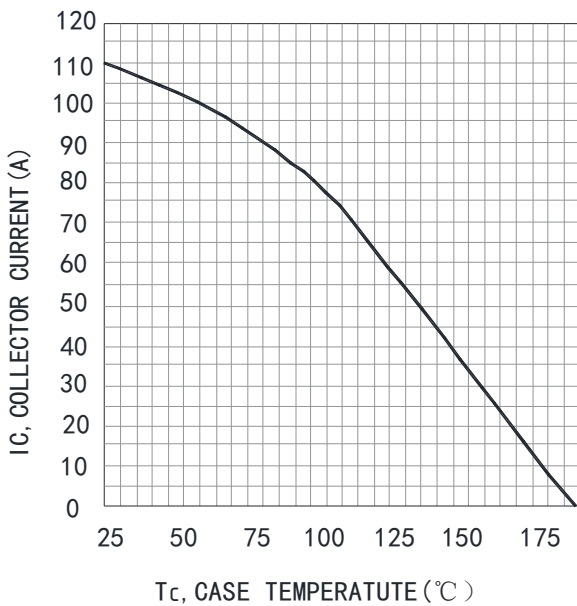

Fig. 3 Collector current as a function of case temperature (V_{GE}≥15V, T_{vj}≤175°C)

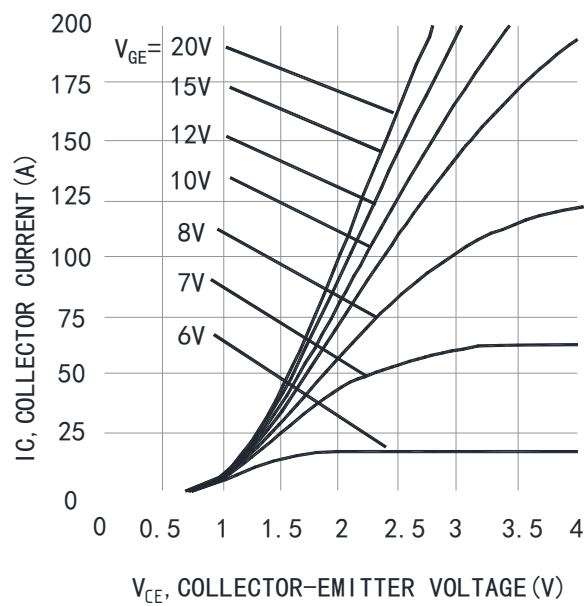

Fig. 4 Typical output characteristic (T_{vj}=25°C)

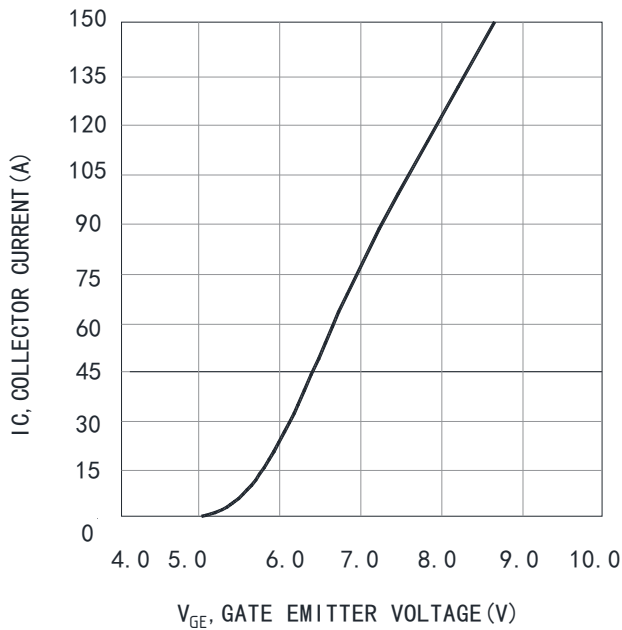

Fig. 5 Typical transfer characteristics ($V_{CE}=20V$)

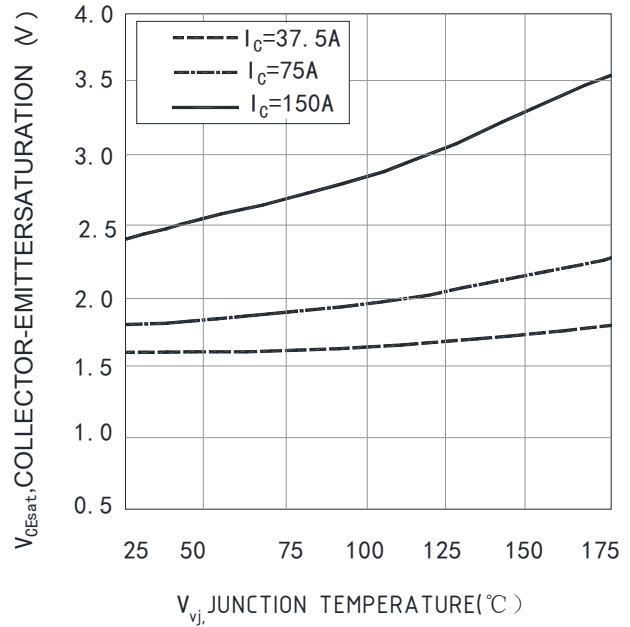

Fig. 6 Typical collector-emitter saturation voltage as a function of junction temperature ($V_{GE}=15V$)

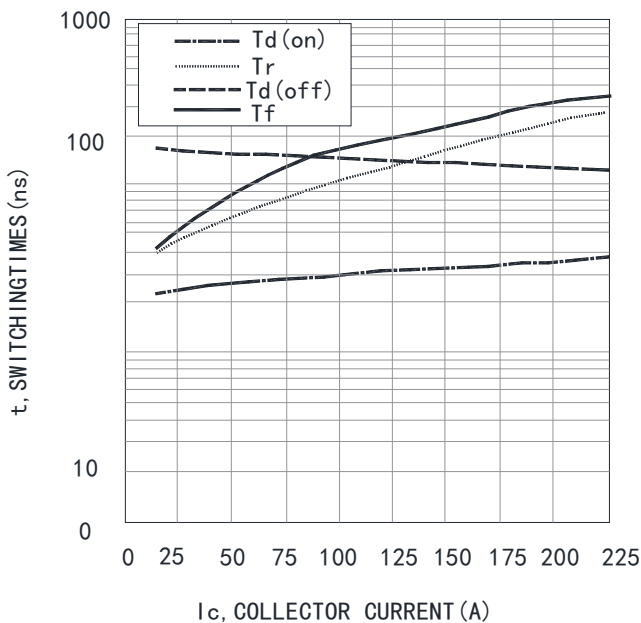

Fig. 7 Typical switching times as a function of collector current (inductive load, $T_{j}=25^{\circ}C$, $V_{CE}=400V$, $V_{GE}=15/0V$, $r_G=8\Omega$)

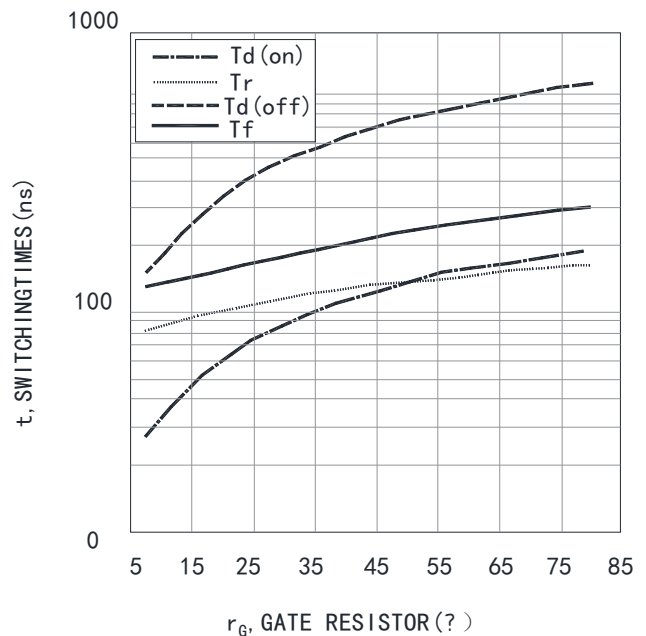

Fig. 8 Typical switching times as a function of gate resistance (inductive load, $T_{j}=25^{\circ}C$, $V_{CE}=400V$, $V_{GE}=15/0V$, $I_C=75A$)

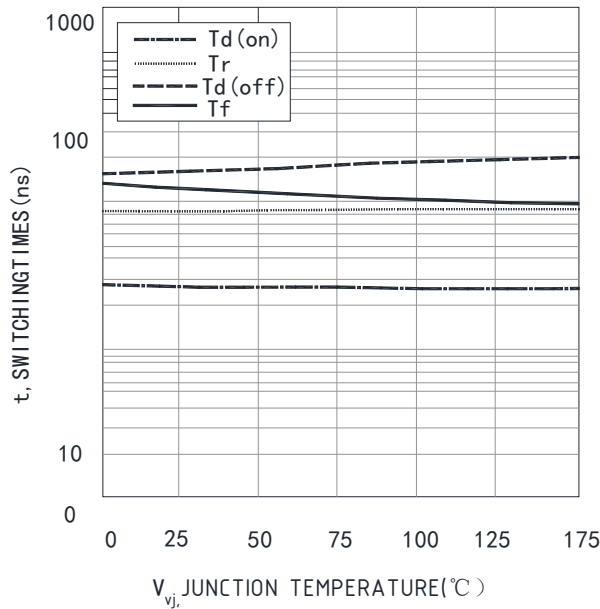

Fig. 9 Typical switching times as a function of junction temperature (inductive load, $V_{CE}=400V$, $V_{GE}=15/0V$, $I_c=75A$, $r_G=8\Omega$)

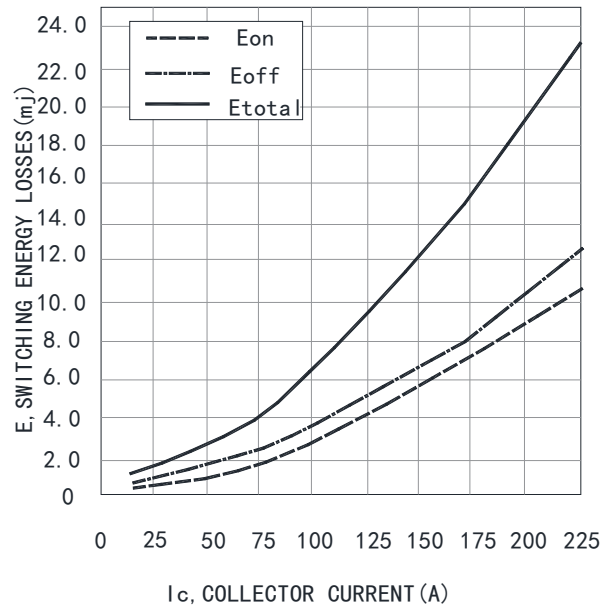

Fig. 10 Typical switching energy losses as a function of collector current (inductive load, $T_{j}=25^\circ C$, $V_{CE}=400V$, $V_{GE}=15/0V$, $r_G=8\Omega$)

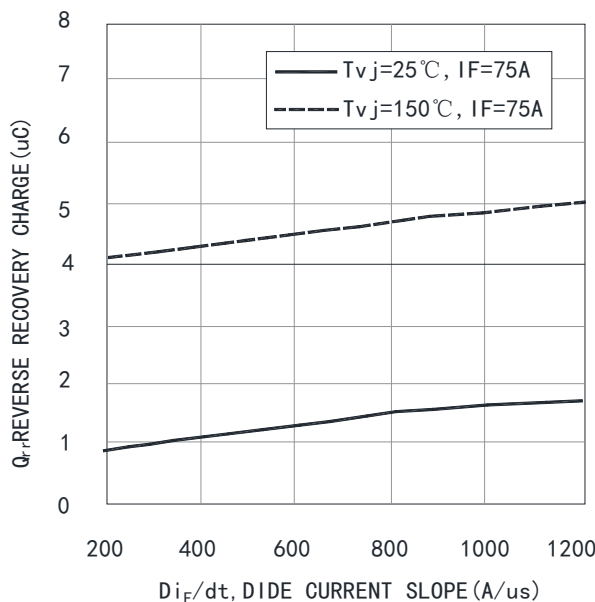

Fig. 11 Typical reverse recovery charge as a function of diode current slope ($V_R=400V$)

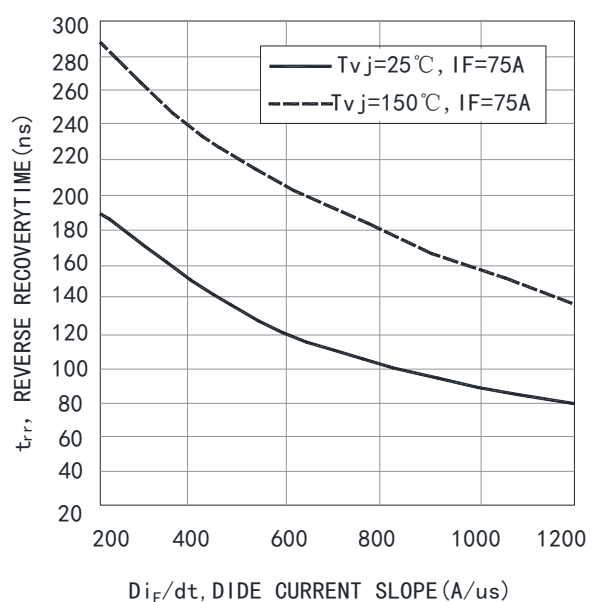

Fig. 12 Typical reverse recovery time as a function of diode current slope ($V_R=400V$)

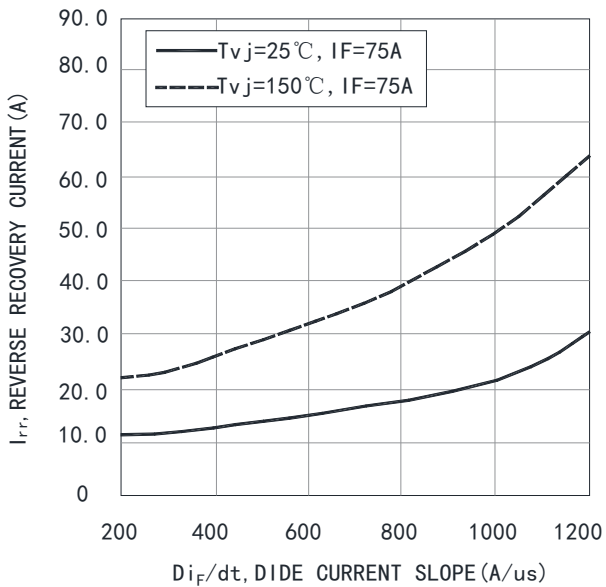

Fig. 13 Typical reverse recovery current as a function of diode current slope (VR=400V)

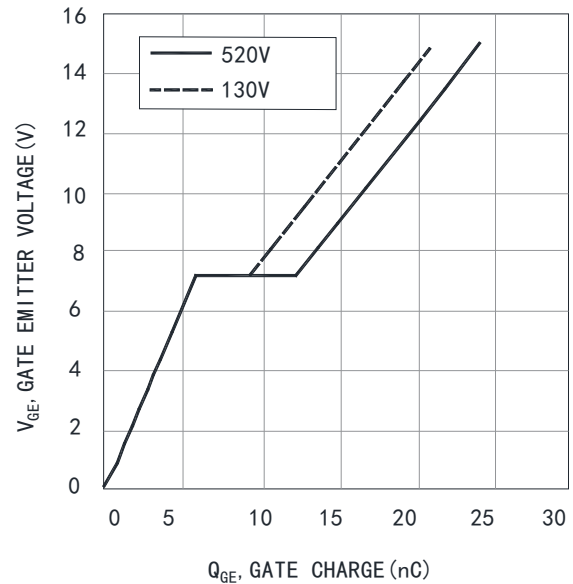

Fig. 14 Typical gate charge (IC=75A)

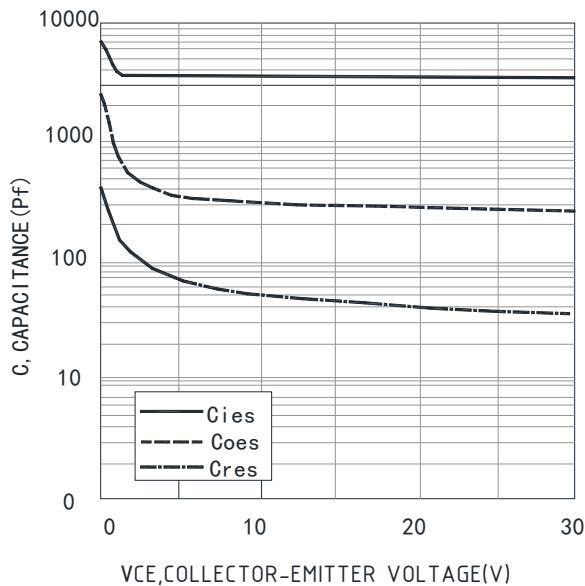

Fig. 15 Typical capacitance as a function of collector-emitter voltage ($V_{GE}=0\text{V}$, $f=1\text{MHz}$)

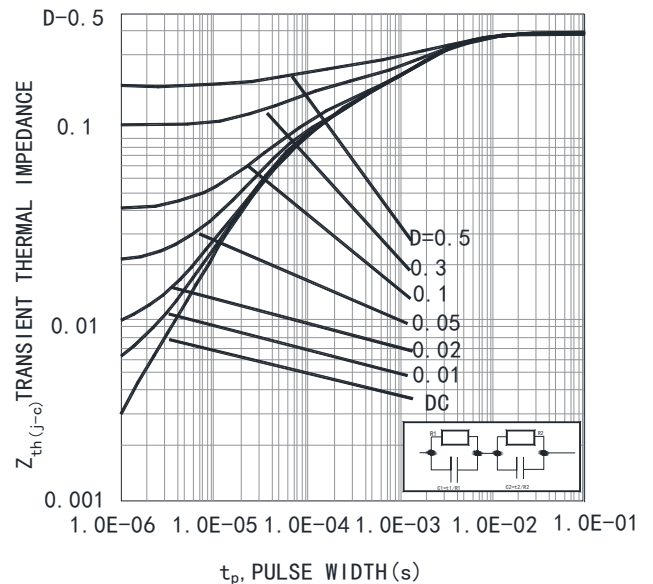

Fig. 16 IGBT transient thermal impedance ($D=tp/T$)



Trench Field-Stop Technology IGBT

PC75H060AB

REV:A / 0

● PART NO. SYSTEM :

P C 15 H 120 A C

